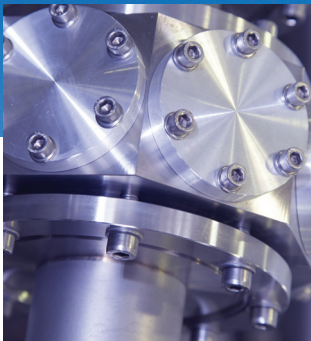


# ARMCO® PH 13-8 Mo

## STAINLESS STEEL

Product Data Bulletin



### Aircraft Parts

### Nuclear Reactor Components

### Petro-Chemical Applications



**ARMCO® PH 13-8 Mo STAINLESS STEEL** is designed for high-performance applications requiring high strength coupled with excellent resistance to corrosion and stress corrosion.

Applications for this high-performance alloy include forgings, cold-headed and machined fasteners, aircraft parts, nuclear reactor components, landing gear parts, pins and lock washers, high-performance shafting, and petro-chemical applications requiring stress corrosion resistance combined with high strength.



1	PRODUCT DESCRIPTION
2	STANDARD HEAT TREATMENTS
3	MECHANICAL PROPERTIES
9	FATIGUE STRENGTH
15	STRESS-STRAIN CURVES
26	VARIATIONS IN HEAT TREATMENT
32	PHYSICAL PROPERTIES
34	MAGNETIC PERMEABILITY
35	FABRICATION
40	CORROSION RESISTANCE

# ARMCO® PH 13-8 Mo STAINLESS STEEL

## Product Description

ARMCO PH 13-8 Mo is a martensitic precipitation hardening stainless steel. It provides a combination of excellent toughness and good transverse mechanical properties, in addition to having the highly desirable corrosion resistance and high strength of a precipitation hardening stainless steel. These properties make PH 13-8 Mo Stainless Steel useful for large sections where notch toughness, high strength and stress corrosion resistance are especially important.

ARMCO PH 13-8 Mo Stainless Steel responds to a simple one-step heat treatment. The precipitation hardening temperature determines the final mechanical properties achieved. This low-temperature heat treatment develops high strengths with minimum distortion and heat scaling.

ARMCO PH 13-8 Mo Stainless Steel is produced by vacuum induction melting plus consumable electrode vacuum arc remelting (designated VIM-VAR). This melting process is used to yield high quality, closely controlled chemical compositions and optimum solidification conditions for aerospace applications.

Composition		(wt %)
Carbon	(C)	0.05 max.
Manganese	(Mn)	0.10 max.
Phosphorus	(P)	0.010 max.
Sulfur	(S)	0.008 max.
Silicon	(Si)	0.10 max.
Chromium	(Cr)	12.25 – 13.25
Nickel	(Ni)	7.50 – 8.50
Aluminum	(Al)	0.90 – 1.35
Molybdenum	(Mo)	2.00 – 2.50
Nitrogen	(N)	0.01 max.

### METRIC PRACTICE

The values shown in this bulletin were established in U.S. customary units. The metric equivalents of U.S. customary units shown may be approximate.

### CONDITIONS AVAILABLE FROM MILL

- |  |   |
|--|---|
| 1) Condition A<br>(Solution Annealed)          | Material for fabrication and final precipitation hardening by the user. |
| 2) Overage for Forging*                        | Allows cold sawing of large sections without cracking.                  |
| 3) Overage and Cold Drawn<br>for Cold Heading* | Maximum softness for cold heading.                                      |
| 4) Other Conditions                            | Inquire for availability.   |

*\*Materials in this condition will not respond to aging treatments without first solution treating.*

### SPECIFICATIONS

ARMCO PH 13-8 Mo Stainless Steel plates, bar, wire, forgings, forging stock and extrusions are covered by the following Specifications, listed as Grade XM-13 and/or as UNS S13800. The grade is also known as WL 1.4534 and X3CrNiMoAl13-8-2.

AMS 5629 Steel, Corrosion-Resistant, Bars, Wire, Forgings, Rings, and Extrusions

AMS 5864 Steel, Corrosion-Resistant, Plate

AMS 5840 Steel, Corrosion and Heat Resistant, Welding Wire

ASTM A564 Hot-Rolled and Cold-Finished Age-Hardening Stainless Steel Bars and Shapes

ASTM A693 Precipitation-Hardening Stainless and Heat-Resisting Steel Plate, Sheet, and Strip

ASTM A705 Age-Hardening Stainless Steel Forgings

# ARMCO® PH 13-8 Mo STAINLESS STEEL

## Standard Heat Treatments

### SINGLE LOW-TEMPERATURE HEAT TREATMENTS

ARMCO PH 13-8 Mo Stainless Steel is usually supplied from our mills in the solution-annealed condition (Condition A). In Condition A, also called solution heat treated or solution treated, the alloy has useful mechanical properties and excellent resistance to stress-corrosion cracking in marine atmospheres. However, to best use ARMCO PH 13-8 Mo Stainless Steel, we suggest a precipitation hardening (PH) heat treatment that provides the desired engineering properties. For optimum combinations of strength, toughness, and resistance to stress-corrosion cracking, most users heat treat with a single treatment at 538 °C (1000 °F) or higher. ARMCO PH 13-8 Mo Stainless Steel has been used successfully in numerous applications in a variety of heat-treated conditions.

Typical properties produced by the standard conditions are shown in the Mechanical Properties section, Table 3. The change in strength caused by variations in heat treatment times and temperatures can be estimated from the curves in Figure 34. These show the changes in strength and hardness produced by changes in time and temperatures.

### MULTIPLE-CYCLE HEAT TREATMENT

As supplied from the mill in Condition A, ARMCO PH 13-8 Mo Stainless Steel can be joined to ARMCO PH 15-7 Mo® or ARMCO 17-7 PH® Stainless Steels and the entire assembly hardened by three-step heat treatments compatible with the latter grades (i.e., RH 950). Inquiries concerning response to braze cycle or other multiple-cycle heat treatments should be directed to AK Steel.

### COLD WORK PLUS HEAT TREATMENT

The highest strength levels in ARMCO PH 13-8 Mo Stainless Steel are obtained by cold working prior to precipitation hardening. This method of obtaining maximum strength is particularly well suited to the production of high-strength corrosion-resistant fasteners.

Data in Figures 36 through 40 show the response of ARMCO PH 13-8 Mo Stainless Steel to this type of fabricating sequence.

**TABLE 1 – ARMCO PH 13-8 Mo LOW TEMPERATURE HEAT TREATMENTS**

#### Condition A

Solution Heat Treated

927 °C (1700 °F) ± 14 °C (57 °F)\*

Oil, Water + Polymer, or Air Cool Below 16 °C (60 °F)

Condition	Precipitation Hardening Temperature ± 6 °C (± 10 °F)	Precipitation Hardening Time (Hours)	Type of Cooling
RH 950**	Within 24 hours after solution treatment, cold treat to -73 °C (-100 °F). Hold at least 2 hours, air warm to room temperature. Followed by:		
	510 °C (950 °F)	4	Air
H 950	510 °C (950 °F)	4	Air
H 1000	538 °C (1000 °F)	4	Air
H 1025	552 °C (1025 °F)	4	Air
H 1050	566 °C (1050 °F)	4	Air
H 1100	593 °C (1100 °F)	4	Air
H 1150	621 °C (1150 °F)	4	Air
H 1150-M	760 °C (1400 °F)	2	Air
	621 °C (1150 °F)	Followed by: 4	

\*Actual solution treating time should be long enough to assure that the steel is heated thoroughly through the section. Bar and wire items can be effectively heat treated in continuous furnaces. In batch-type furnaces, it is recommended that parts be held at temperature 15 to 30 minutes after temperature is reached to assure uniformity.

\*\*RH 950 heat treatment incorporates a refrigeration cycle after solution treatment prior to precipitation hardening at 510 °C (950 °F).



# ARMCO® PH 13-8 Mo STAINLESS STEEL

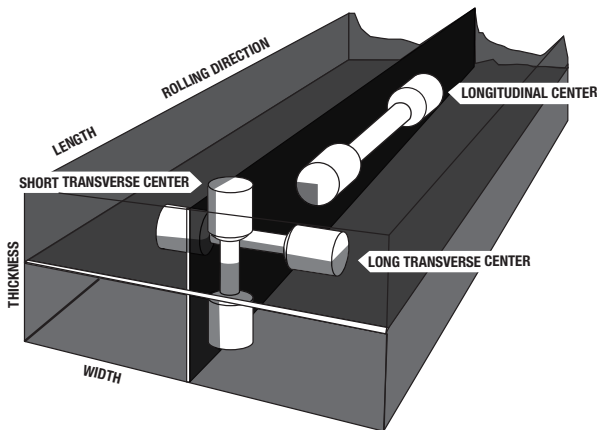
## Mechanical Properties

### ORIENTATION AND LOCATION OF TEST SPECIMENS

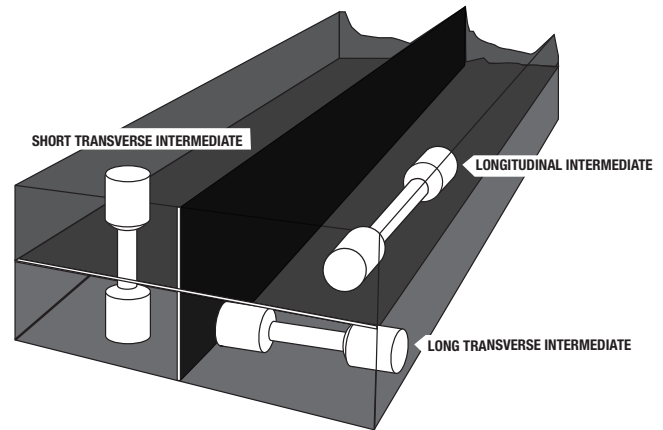
ARMCO PH 13-8 Mo Stainless Steel is especially useful in many applications requiring excellent mechanical properties in the long transverse and short transverse directions, as well as in the longitudinal direction (direction of rolling). The orientation and location of the test specimen and product section size are receiving more emphasis in the determination of design values. The data included in this bulletin are identified both as the orientation of specimen and location from which the test specimens were taken. Orientation and location of test specimens and their designations are shown in Figures 1A and 1B.

Sketches showing the orientation and location of test specimens.

**FIGURE 1A**



**FIGURE 1B**



1) Transverse properties cannot be determined if bar dimensions are under 76.2 mm (3 in.) in the test direction.

2) In rounds, squares, and hexagon bars, no short transverse direction exists.

**TABLE 2 – PROPERTIES\* ACCEPTABLE FOR MATERIAL SPECIFICATION UP TO 300 mm (12 in.) SECTION SIZE**

Property	Condition A		Condition RH 950		Condition H 950		Condition H 1000		Condition H 1025		Condition H 1050		Condition H 1100		Condition H 1150		Condition H 1150 M	
	Long.	Trans.	Long.	Trans.	Long.	Trans.	Long.	Trans.	Long.	Trans.	Long.	Trans.	Long.	Trans.	Long.	Trans.	Long.	Trans.
UTS, MPa (ksi)	–	–	1517 (220)	1517 (220)	1517 (220)	1517 (220)	1413 (205)	1413 (205)	1276 (185)	1276 (185)	1207 (175)	1207 (175)	1034 (150)	1034 (150)	931 (135)	931 (135)	862 (125)	862 (125)
0.2% YS, MPa (ksi)	–	–	1413 (205)	1413 (205)	1413 (205)	1413 (205)	1310 (190)	1310 (190)	1207 (175)	1207 (175)	1138 (165)	1138 (165)	931 (135)	931 (135)	620 (90)	620 (90)	586 (85)	586 (85)
Elong. % in 4D <sub>0</sub>	–	–	10	10	10	10	10	10	11	11	12	12	14	14	14	14	16	16
Red of Area, %	–	–	45	35	45	35	50	40	50	45	50	45	50	50	50	50	55	55
HRC	–	–	45	45	45	45	43	43	41	41	40	40	34	34	30	30	26	26
HB	363 max.		430	430	430	430	400	400	–	–	372	372	313	313	283	283	–	–

\*All properties are minimum except as noted.

# ARMCO® PH 13-8 Mo STAINLESS STEEL

## Mechanical Properties

TABLE 3 – TYPICAL MECHANICAL PROPERTIES\*

Property	Condition A		RH 950		H 950		H 1000		H 1050		H 1100		H 1150		H 1150-M	
	Long.	Trans.	Long.	Trans.	Long.	Trans.	Long.	Trans.	Long.	Trans.	Long.	Trans.	Long.	Trans.	Long.	Trans.
UTS, MPa (ksi)	1103 (160)	1103 (160)	1620 (235)	1620 (235)	1551 (225)	1551 (225)	1482 (215)	1482 (215)	1310 (190)	1310 (190)	1103 (160)	1103 (160)	1000 (145)	1000 (145)	896 (130)	896 (130)
0.2% YS, MPa (ksi)	827 (120)	827 (120)	1482 (215)	1482 (215)	1448 (210)	1448 (210)	1413 (205)	1413 (205)	1241 (180)	1241 (180)	1034 (150)	1034 (150)	724 (105)	724 (105)	586 (85)	586 (85)
Elong. % in 4D <sub>0</sub>	17	17	12	12	12	12	13	13	15	15	18	18	20	20	22	22
Reduction of Area, %	65	65	45	35	50	40	55	50	55	55	60	60	63	63	70	70
HRC	33	33	48	48	47	47	45	45	43	43	35	35	33	33	32	32
Impact, Charpy V-Notch, J (ft•lbs)**	81 (60)	54 (40)	27 (20)	14 (10)	27 (20)	17 (15)	40 (30)	27 (20)	68 (50)	40 (30)	81 (60)	54 (40)	108 (80)	80 (60)	162 (120)	108 (80)

\*Specimen location center or intermediate.

\*\*Developed on 25 – 75 mm (1 – 3 in.) diameter bars. Typical properties derived from average test values developed from production orders.

TABLE 4 – TORSION YIELD STRENGTH\*

Condition	Torsion Shear Modulus (G) GPa (Mpsi)	0.2% Shear Strain Offset ( $\gamma$ ), MPa (ksi)	0.2% Normal Strain Offset ( $\epsilon$ ) MPa (ksi)	Modulus of Rupture MPa (ksi)
H 950	76 (11.1)	945 (137.1)	1020 (148.0)	1271 (184.4)
H 1000	75 (10.9)	924 (134.0)	987 (143.2)	1185 (171.9)

\*Average of two readings.

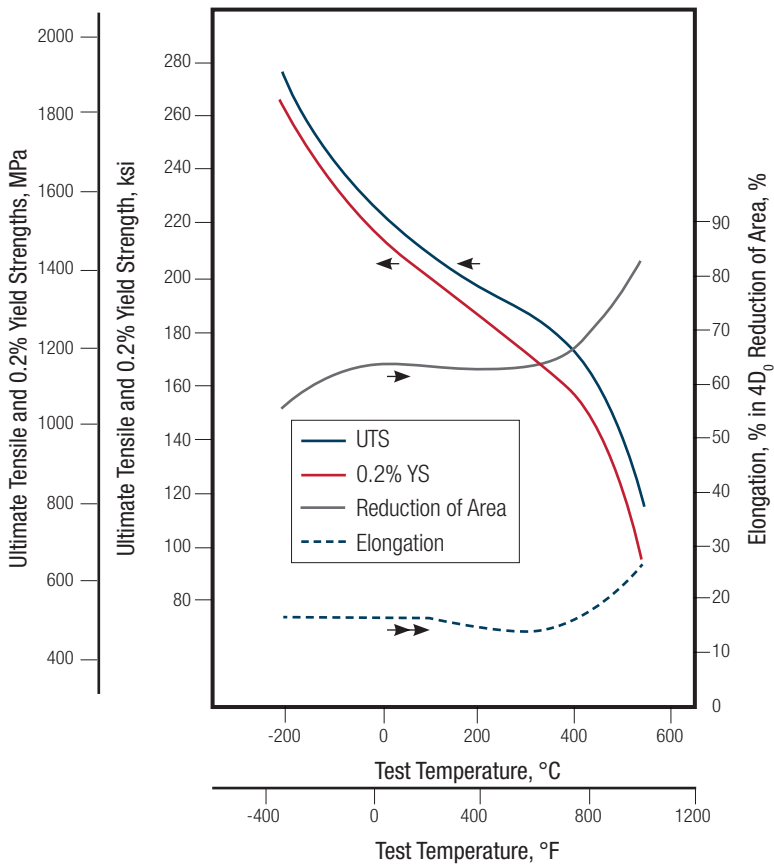
The ratio of torsional yield strength, determined from a 0.2% shear strain ( $\gamma$ ) offset, to tensile yield strength is approximately 64% for material in Condition H 950.



# ARMCO® PH 13-8 Mo STAINLESS STEEL

## Mechanical Properties

**FIGURE 2 – SHORT-TIME ELEVATED TEMPERATURE TENSILE PROPERTIES  
CONDITION H 1000\***



\*Specimens machined from 19 mm (0.75 in.) round bar stock. Held at temperature 30 minutes before test. Constructed from data from one heat.

# ARMCO® PH 13-8 Mo STAINLESS STEEL

## Mechanical Properties

**TABLE 5 – SHORT-TIME ELEVATED TEMPERATURE PROPERTIES\*  
CONDITION H 1100 – 25 mm (1 in.) DIAMETER BAR**

Test Temperature, °C (°F)	UTS, MPa (ksi)	0.2% YS, MPa (ksi)	Elongation % in 4D <sub>0</sub>	Reduction of Area %
27 (80)	1151 (167)	1000 (145)	22	69
93 (200)	1069 (155)	1007 (146)	23	69
149 (300)	1062 (154)	1007 (146)	22	70
204 (400)	1020 (148)	972 (141)	20	70
260 (500)	993 (144)	951 (138)	19	69
316 (600)	979 (142)	931 (135)	18	69
371 (700)	951 (138)	889 (129)	18	69

\*Data represents average of triplicate tests from 3 heats.

### IMPACT STRENGTH

Table 6 illustrates the high impact strength of ARMCO PH 13-8 Mo Stainless Steel at sub-zero temperatures. These values are exceptional for a material with the strength of ARMCO PH 13-8 Mo Stainless Steel.

AK Steel suggests higher aging temperatures for impact applications at low temperatures down to -79 °C (-110 °F). At room temperature, the impact energy capability is outstanding for a high-strength steel.

**TABLE 6 – TYPICAL CHARPY V-NOTCH IMPACT STRENGTH AT SUB-ZERO TEMPERATURES\* 199 mm (7.5 in.) SQUARE FORGED BLOOM**

Test Temperature, °C (°F)	Condition H 950 J (ft·lbs)	Condition H 1000 J (ft·lbs)	Condition H 1050 J (ft·lbs)	Condition H 1100 J (ft·lbs)	Condition H 1150-M J (ft·lbs)
22 (72)	32.5 (24)	40.7 (30)	54.0 (40)	68.0 (50)	162.7 (120)
0 (32)	14.9 (11)	27.1 (20)	47.3 (35)	62.4 (46)	–
-53 (-65)	9.5 (7)	16.3 (12)	29.8 (22)	51.0 (38)	–
-79 (-110)	6.8 (5)	10.8 (8)	17.9 (13)	43.2 (32)	119.3 (88)
-115 (-175)	4.1 (3)	8.1 (6)	–	–	96.3 (71)
-140 (-220)	2.7 (2)	6.8 (5)	8.1 (6)	19.0 (14)	–
-196 (-320)	2.7 (2)	5.4 (4)	5.4 (4)	6.8 (5)	40.7 (30)

\*Data represent average values from four heats.

**TABLE 7 – TYPICAL CHARPY V-NOTCH IMPACT STRENGTH\* CONDITION H 1100 – 25 mm (1 in.) DIAMETER BAR\***

Heat	Test Temperature			
	Room Temperature		-12 °C (10 °F)	
	J (ft·lbs)	Lateral Expansion mils.	J (ft·lbs)	Lateral Expansion mils.
A	178 (131)	57	168 (124)	54
B	175 (129)	53	153 (113)	51
C	190 (140)	56	180 (133)	60

\*Data represent average values of 3 tests from each heat.





# ARMCO® PH 13-8 Mo STAINLESS STEEL

## Mechanical Properties

TABLE 8 – PRECRACKED CHARPY IMPACT STRENGTH

Condition	25.4 mm (1 in.) Thick Plate**		76.2 x 203.2 mm (3 x 8 in.) Section**		25.4 mm (1 in.) Bar***
	Test Direction*	Precracked Charpy, W/A mm·N/mm <sup>2</sup> (in.-lbs/in <sup>2</sup> )	Test Direction*	Precracked Charpy, W/A mm·N/mm <sup>2</sup> (in.-lbs/in <sup>2</sup> )	Precracked Charpy, W/A mm·N/mm <sup>2</sup> (in.-lbs/in <sup>2</sup> )
H 950	L	162 (925)	L	149 (851)	105 (600)
	T	133 (760)	ST	150 (856)	–
H 1000	L	449 (2565)	–	–	245 (1400)
	T	367 (2095)	–	–	–
H 1050	L	858 (4905)	L	1398 (7990)	–
	T	1104 (6310)	ST	1339 (7645)	–

\*L – Longitudinal

T – Transverse

ST – Short Transverse

\*\*Average of duplicate values from one heat.

\*\*\*Average of duplicate values from eight heats.

TABLE 9 – NOTCH TENSILE STRENGTH

Notch Factor	Test Temperature, °C (°F)	Condition	UTS, MPa (ksi)	0.2% YS, MPa (ksi)	Notch Strength, MPa (ksi)	NS/UTS
3.8	27 (80)	H 950	1583 (229.6)	1451 (210.5)	2228 (331.8)	1.44
		H 1000	1518 (220.2)	1460 (211.8)	2433 (354.5)	1.61
5.25	27 (80)	H 950	1583 (229.6)	1451 (210.5)	2302 (334.0)	1.46
		H 1000	1518 (220.2)	1460 (211.8)	2392 (347.0)	1.57
3.8	-79 (-110)	H 950	1739 (252.2)	–	1869 (271.2)	1.08
		H 1000	1617 (234.5)	–	2646 (389.9)	1.64
5.25	-79 (-110)	H 950	1738 (252.2)	–	1669 (242.0)	0.96
		H 1000	1616 (234.5)	–	2571 (*373.0)	1.59

\*Data represent one test on 19 mm (0.75 in.) round bar stock.

All other data represent average data on two tests on 19 mm (0.75 in.) round bar stock.

TABLE 10 – TYPICAL PLANE STRAIN FRACTURE TOUGHNESS\*\*\*

Direction		K <sub>IC</sub> , MPa √m (ksi √in.)*			
Loading	Crack Growth	H 950	H 1000	H 1025	H 1050
R	W	83 (75)	110 (100)	138 (125)	165 (150)
W	R	77 (70)	105 (95)	–	–

R = Rolling direction, W = width

\*K<sub>IC</sub> values were developed from tests conducted at -79 °C (-110 °F) and determined from Plane Strain Crack Size Factor (K<sub>IC</sub>/σ<sub>YS</sub>)<sup>2</sup> as reported in NASA Technical Note TN 4998, "Crack Toughness Characteristics of Several Alloys for Use in Heavy Sections of High Speed Aircraft" by Raymond T. Busbey and William F. Brown, Jr., Lewis Research Center, Cleveland, Ohio, January 1969, as follows:

Loading Direction	Crack Growth Direction	K <sub>IC</sub> , MPa √m (ksi √in.)
R	W	55 (50)
W	R	50 (45)

\*\*\*These data represent average values from ten heats. There is a wide variation in the fracture toughness results which are affected by heat and section size. Variations from 50 MPa √m (50 ksi √in.) to 220 MPa √m (200 ksi √in.) have been observed.

# ARMCO® PH 13-8 Mo STAINLESS STEEL

## Mechanical Properties

TABLE 11 – PIN BEARING TEST\*\* CONDITION H 1000

Test Direction	e/D = 1.5		e/D = 2.0	
	Bearing Yield Strength*, MPa (ksi)	Bearing Strength, MPa (ksi)	Bearing Yield Strength*, MPa (ksi)	Bearing Strength, MPa (ksi)
Longitudinal	2000 (290)	2275 (330)	2586 (375)	3034 (440)
Transverse	2068 (300)	2344 (340)	2620 (380)	3102 (450)

\*Offset = 2% of Pin Diameter.

\*\*Data represent average of duplicate tests from three heats.

TABLE 12 – SHEAR TEST\* CONDITION H 1000

Test Direction	Shear Strength, MPa (ksi)
Longitudinal	910 (132)
Transverse	910 (132)

\*Data represent average of duplicate tests from four heats, 56 x 150 mm (2.25 x 6 in.) forgings.

TABLE 13 – COMPRESSION TEST\*

Bar Size, mm (in.)	Direction Test	Compressive Yield Strength, MPa (ksi)					
		Condition H 950		Condition H 1000		Condition H 1050	
		0.02%	0.2%	0.02%	0.2%	0.02%	0.2%
22 (0.875) Diameter	Longitudinal	1248 (181)	1517 (220)	1352 (196)	1517 (220)	1200 (174)	1365 (198)
56 x 150 (2.25 x 6)	Longitudinal	—	—	—	1524 (221)	—	—
	Transverse	—	—	—	1517 (220)	—	—

\*Data represent average of duplicate tests from four heats.



# ARMCO® PH 13-8 Mo STAINLESS STEEL

## Fatigue Strength

TABLE 14 – ROTATING BEAM FATIGUE STRENGTH\* CONDITION H 1000

Notch Factor $K_t$	Notch Radius, mm (in.)	Maximum Stress, MPa (ksi)	Fatigue Strength Number of Cycles
1 (Smooth)	—	1103 (160)	40 000
		1103 (160)	61 000
		965 (140)	102 000
		965 (140)	111 000
		827 (120)	336 000
		827 (120)	589 000
		827 (120)	959 000
		758 (110)	28 935 000
		724 (105)	126 218 000
		690 (100)	100 599 000**
2.8	0.025 (0.010)	690 (100)	12 000
		552 (80)	20 000
		414 (60)	65 000
		345 (50)	319 000
		345 (50)	409 000
		345 (50)	366 000
		310 (45)	1 056 000
		276 (40)	118 271 000**
3.8	0.013 (0.005)	552 (80)	18 000
		414 (60)	59 000
		345 (50)	227 000
		310 (45)	451 000
		310 (45)	219 000
		276 (40)	926 000
		276 (40)	1 085 000
		241 (35)	127 901 000**

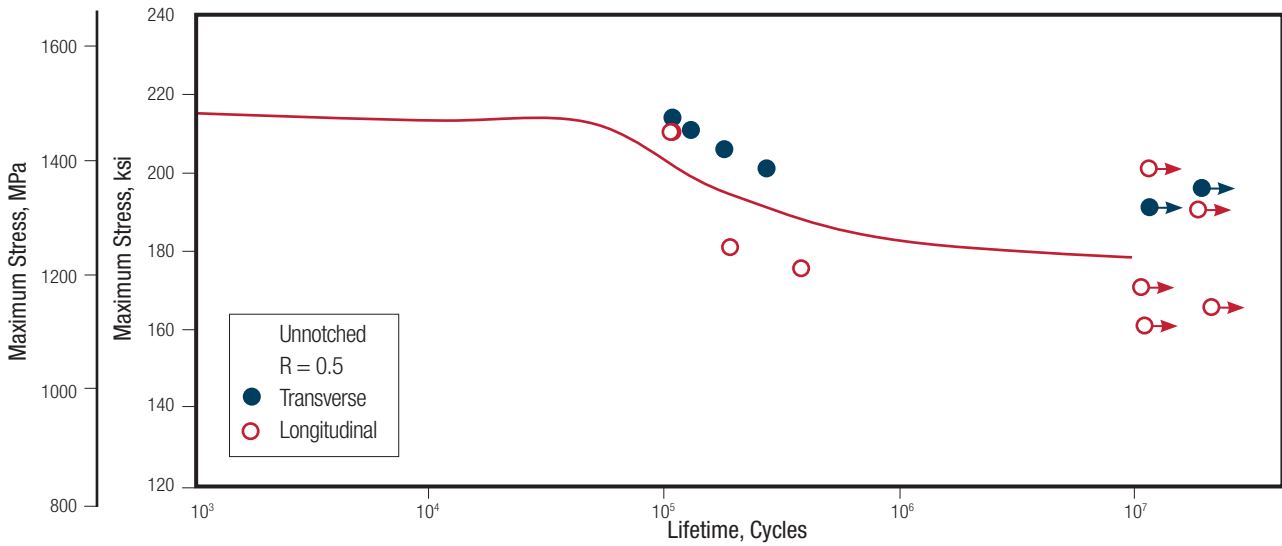
\*Specimens tested in R.R. Moore Rotating Beam Machine. Samples cut from 19 mm (0.75 in.) round bar stock. Data represent single test values from one heat.

\*\*Test stopped – specimen unbroken.

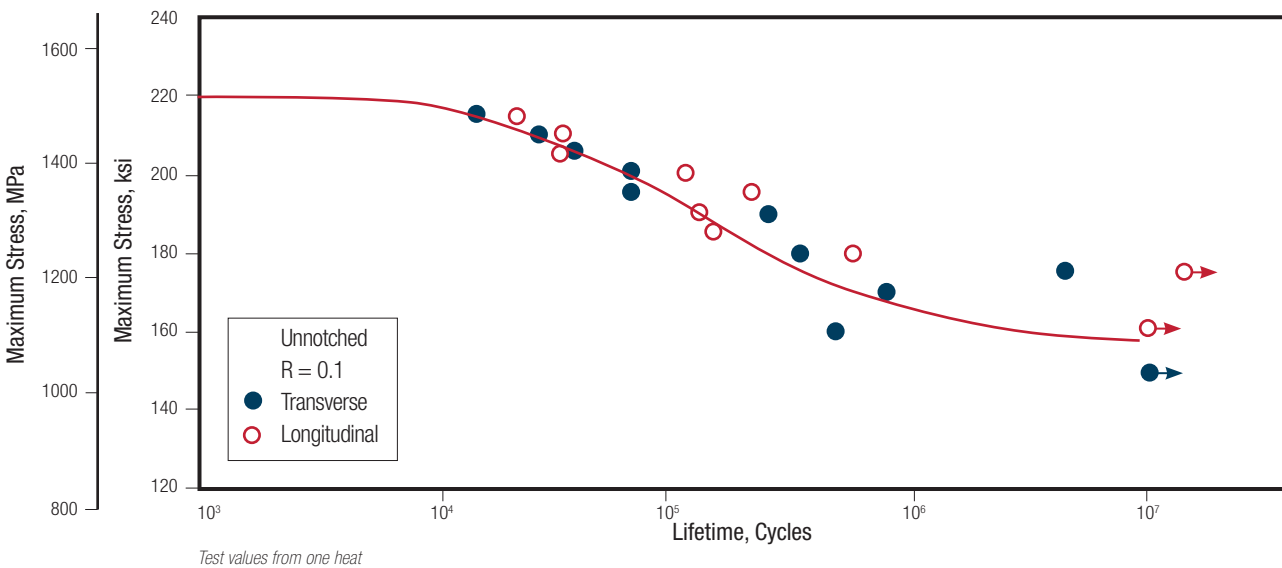
# ARMCO® PH 13-8 Mo STAINLESS STEEL

## Fatigue Strength

**FIGURE 3 – FATIGUE TEST RESULTS FOR UNNOTCHED LONGITUDINAL AND TRANSVERSE SPECIMENS OF CONDITION H 1000 ARMCO PH 13-8 Mo STAINLESS STEEL AT A STRESS RATIO OF R = 0.5**



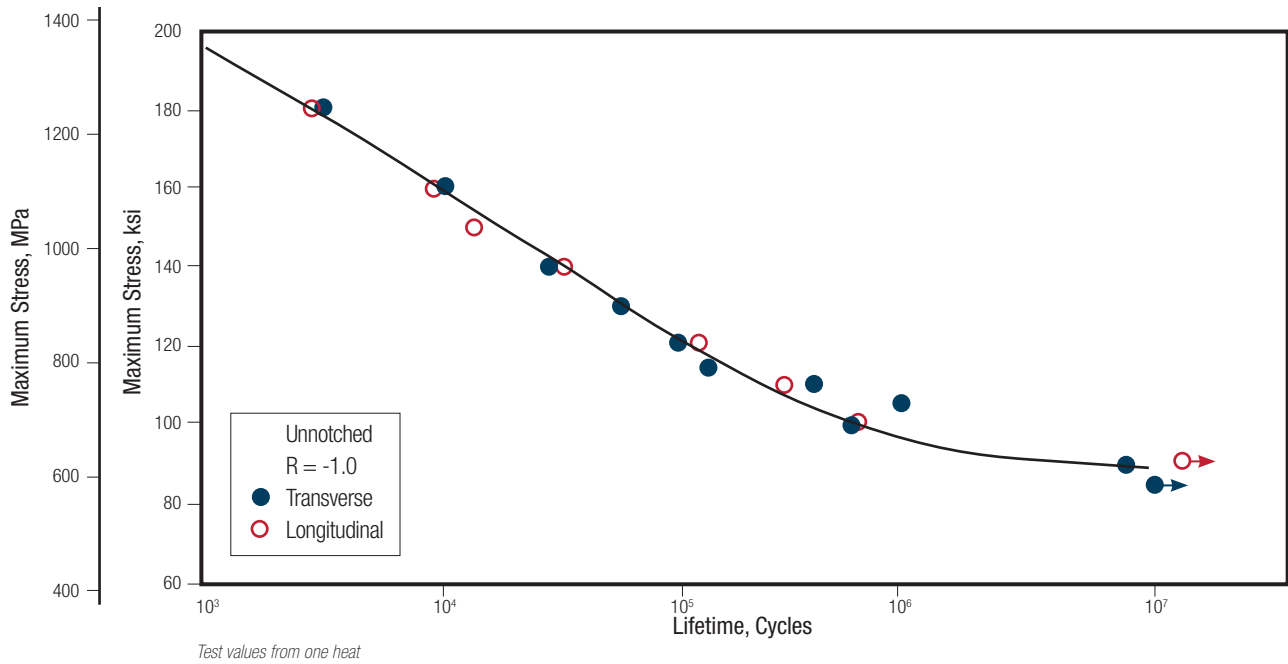
**FIGURE 4 – FATIGUE TESTS RESULTS FOR UNNOTCHED LONGITUDINAL AND TRANSVERSE SPECIMENS OF CONDITION H 1000 ARMCO PH 13-8 Mo STAINLESS STEEL AT A STRESS RATIO OF R = 0.1**



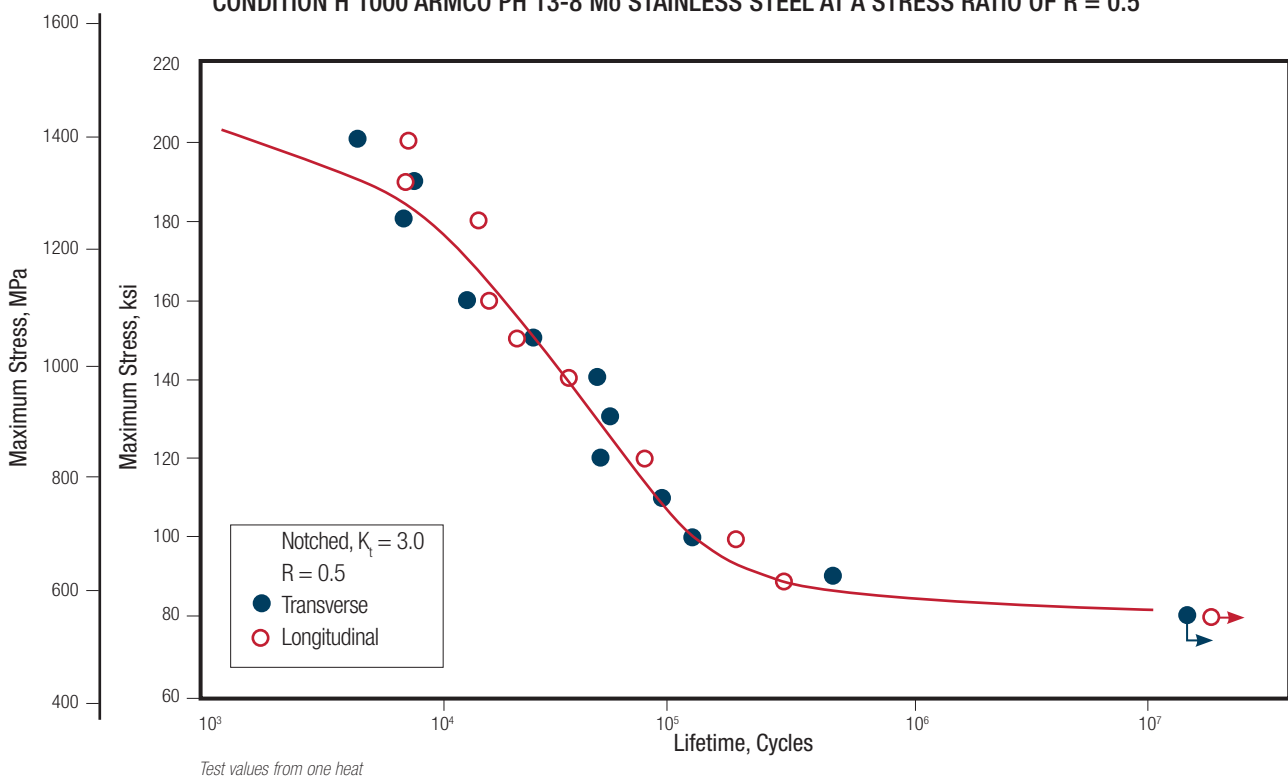
# ARMCO® PH 13-8 Mo STAINLESS STEEL

## Fatigue Strength

**FIGURE 5 – FATIGUE TEST RESULTS FOR UNNOTCHED LONGITUDINAL AND TRANSVERSE SPECIMENS OF CONDITION H 1000 ARMCO PH 13-8 Mo STAINLESS STEEL AT A STRESS RATIO OF R = -1.0**



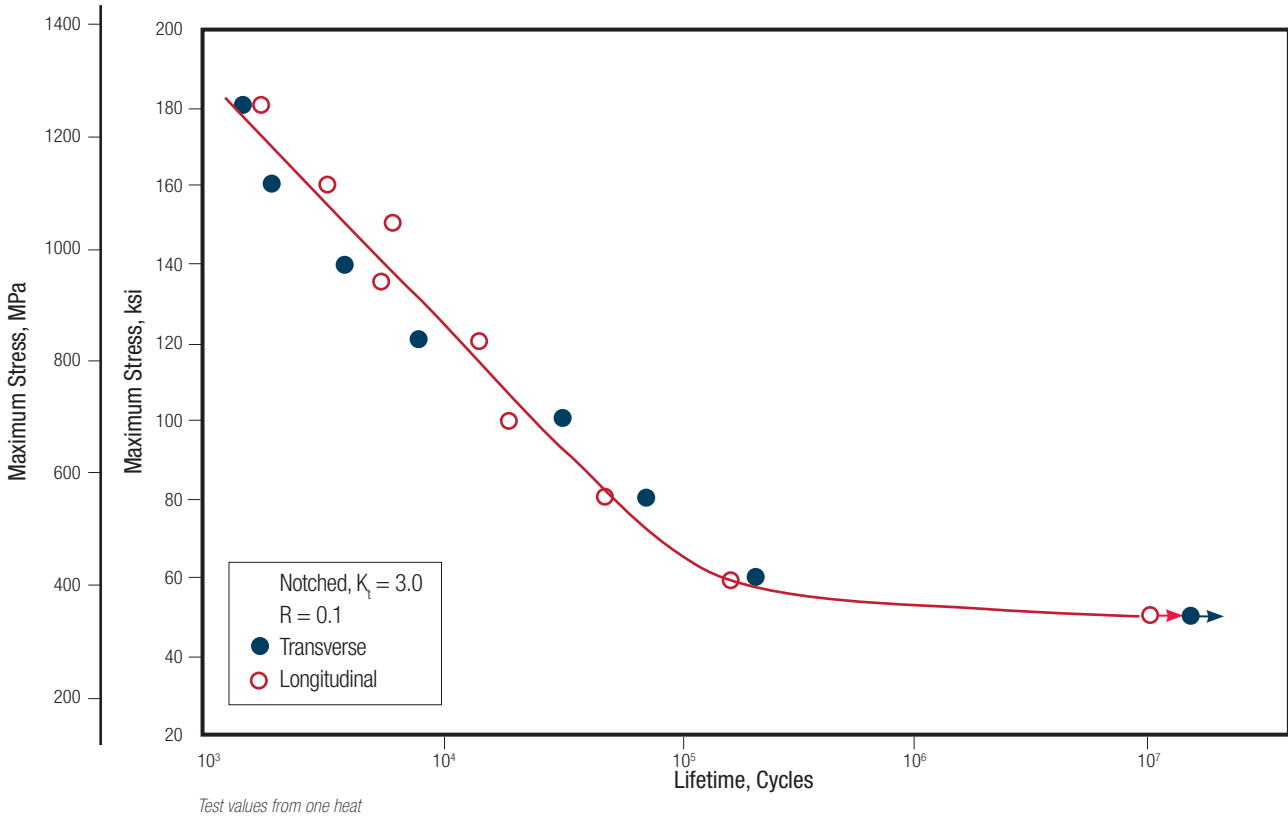
**FIGURE 6 – FATIGUE TEST RESULTS FOR NOTCHED ( $K_t = 3.0$ ) LONGITUDINAL AND TRANSVERSE SPECIMENS OF CONDITION H 1000 ARMCO PH 13-8 Mo STAINLESS STEEL AT A STRESS RATIO OF R = 0.5**



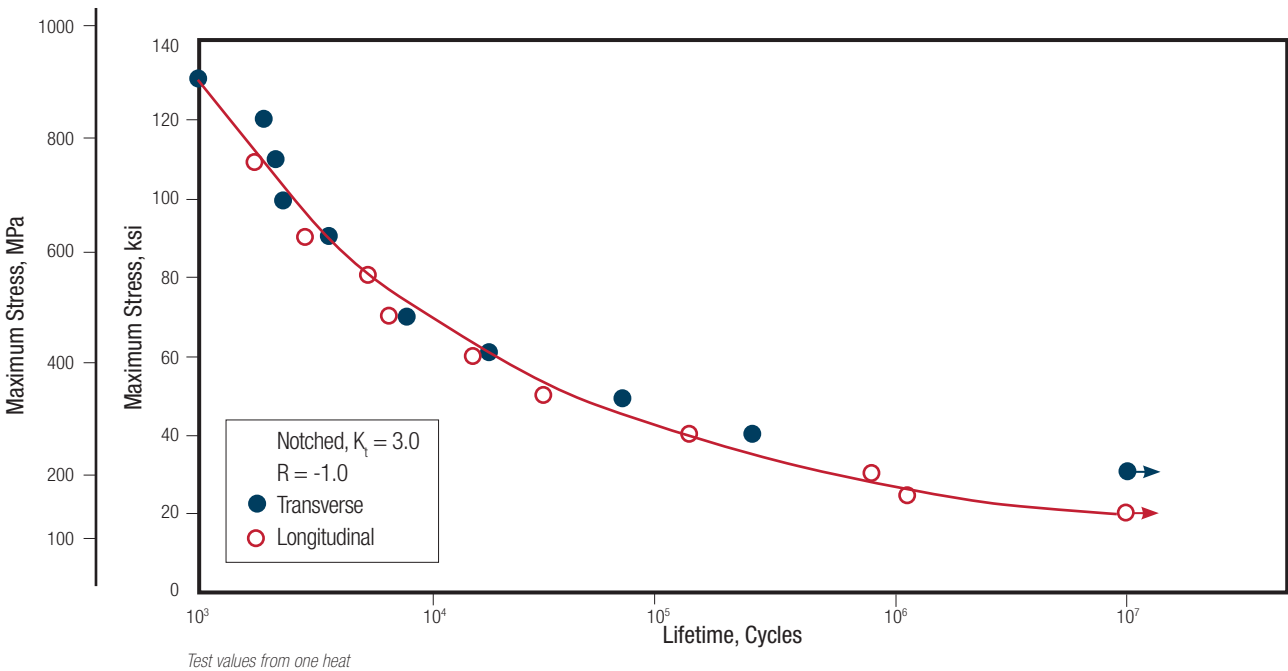
# ARMCO® PH 13-8 Mo STAINLESS STEEL

## Fatigue Strength

**FIGURE 7 – FATIGUE TEST RESULTS FOR NOTCHED ( $K_t = 3.0$ ) LONGITUDINAL AND TRANSVERSE SPECIMENS OF CONDITION H 1000 ARMCO PH 13-8 Mo STAINLESS STEEL AT A STRESS RATIO OF  $R = 0.1$**

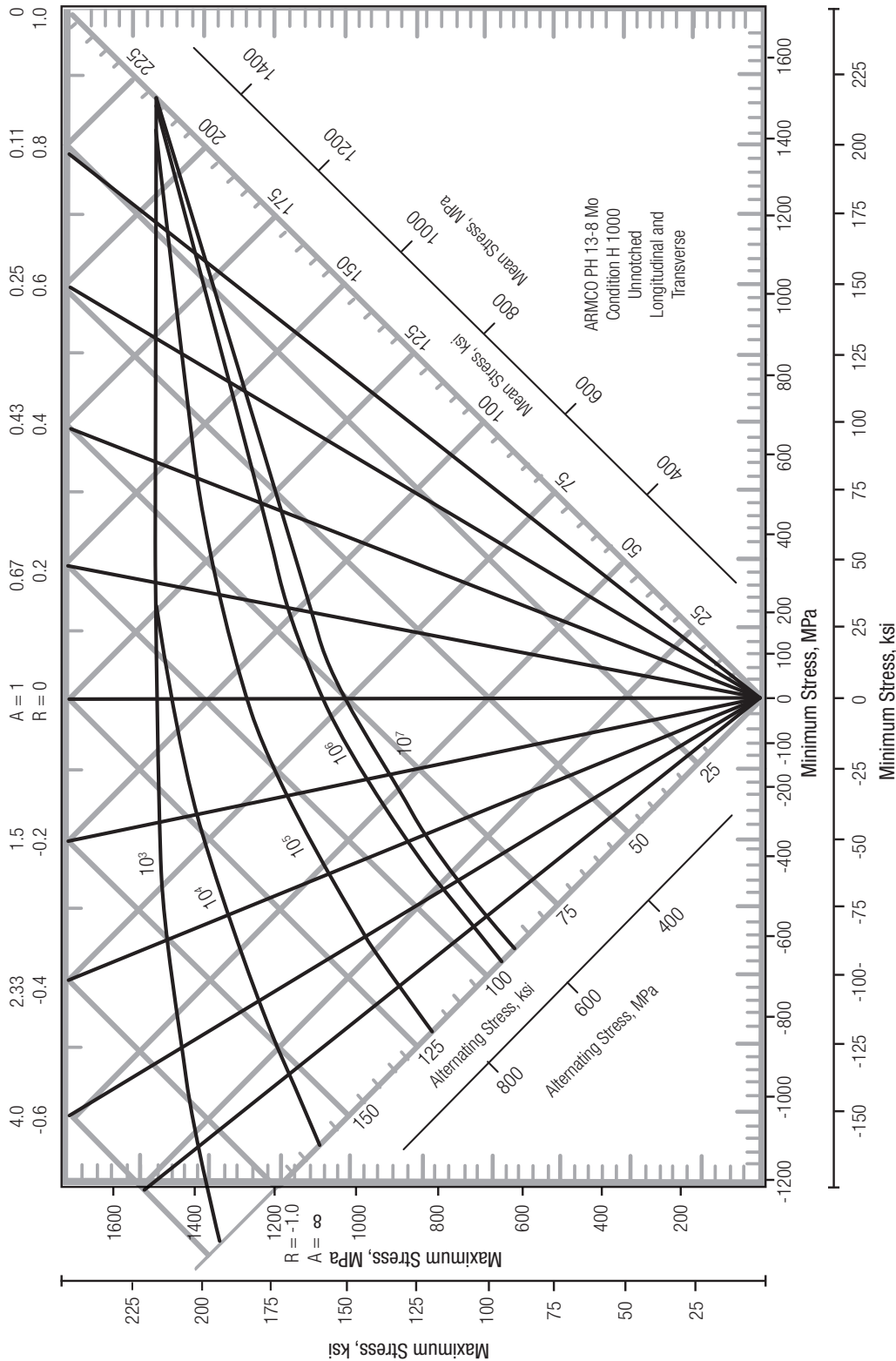


**FIGURE 8 – FATIGUE TEST RESULTS FOR NOTCHED ( $K_t = 3.0$ ) LONGITUDINAL AND TRANSVERSE SPECIMENS OF CONDITION H 1000 ARMCO PH 13-8 Mo STAINLESS STEEL AT A STRESS RATIO OF  $R = -1.0$**



# ARMCO® PH 13-8 Mo STAINLESS STEEL

## Fatigue Strength



**FIGURE 9 – Constant-life diagram for axial-load, unnotched, fatigue behavior of ARMCO PH 13-8 Mo Stainless Steel.\***  
Constructed using Figures 3, 4 and 5.

\*A duplicate program was run on another heat and results were essentially the same.

# ARMCO® PH 13-8 Mo STAINLESS STEEL

## Fatigue Strength

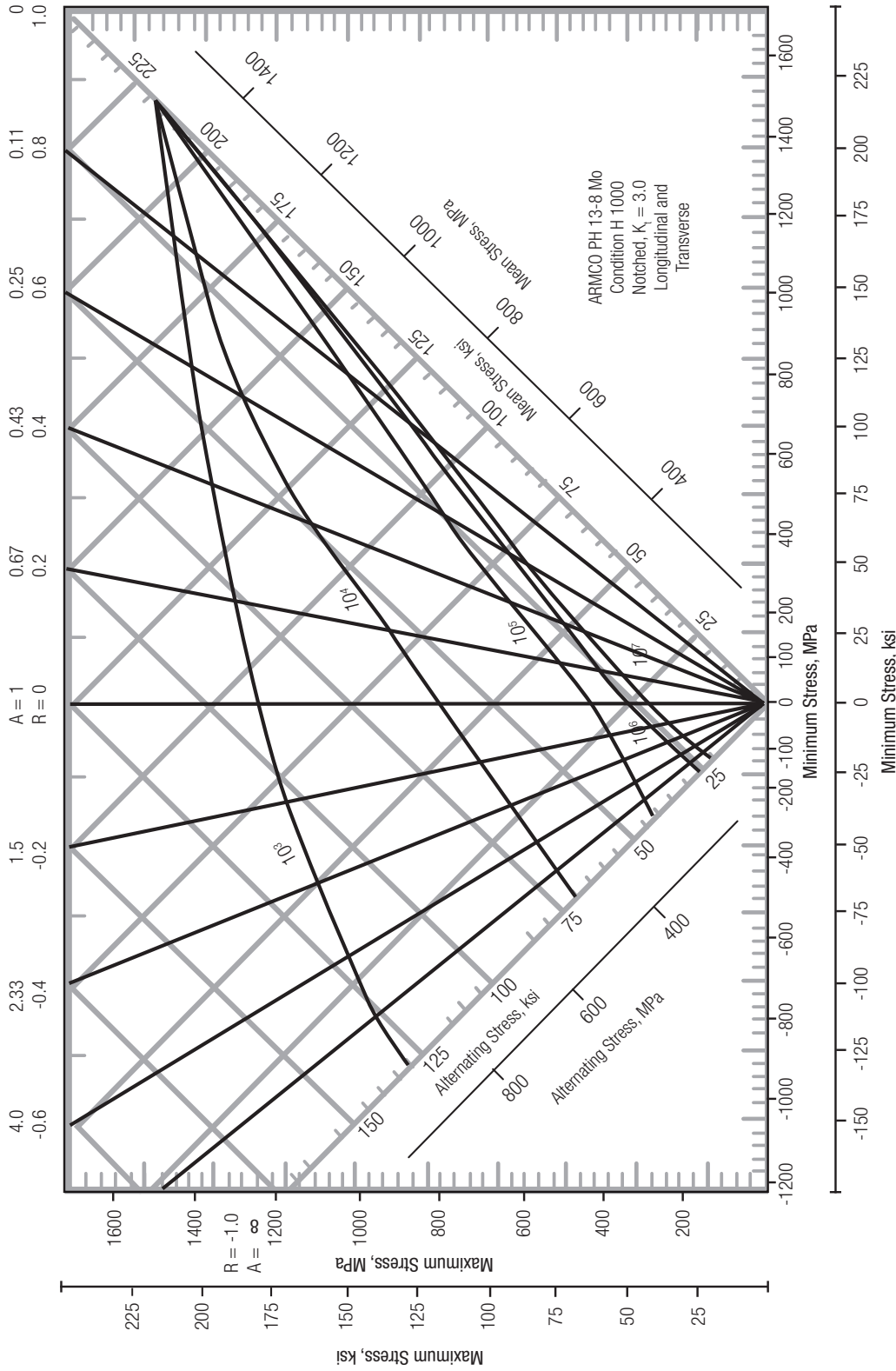


FIGURE 10 – Constant-life diagram for axial-load notched ( $K_t = 3.0$ ), fatigue behavior of ARMCO PH 13-8 Mo Stainless Steel. Constructed using Figures 6, 7 and 8.





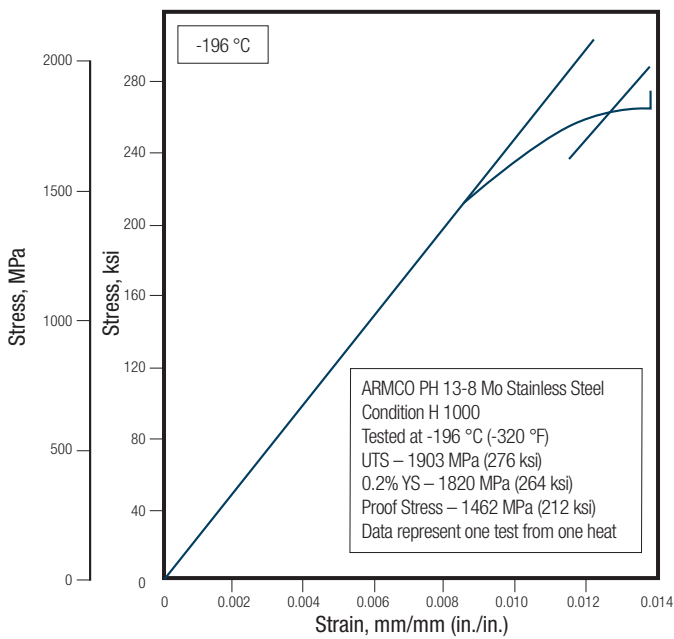
# ARMCO® PH 13-8 Mo STAINLESS STEEL

## Stress-Strain Curves

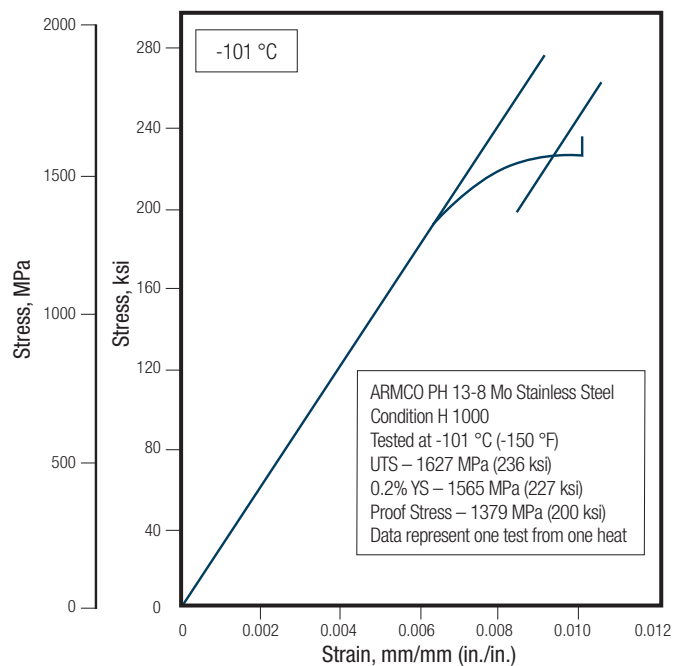
### TYPICAL STRESS-STRAIN CURVES

The following curves were developed using a Class A extensometer, not accurate for Young's Modulus.

**FIGURE 11 – EFFECT OF TEST TEMPERATURE ON CONDITION H 1000 – TENSION**



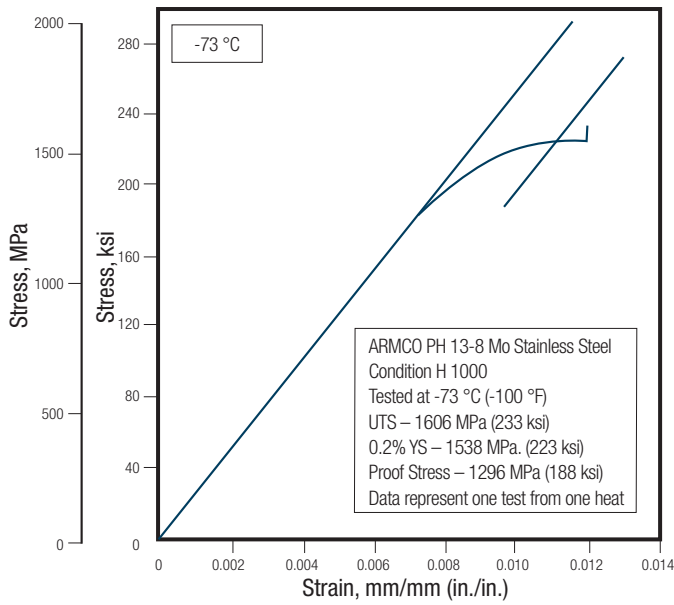
**FIGURE 12 – EFFECT OF TEST TEMPERATURE ON CONDITION H 1000 – TENSION**



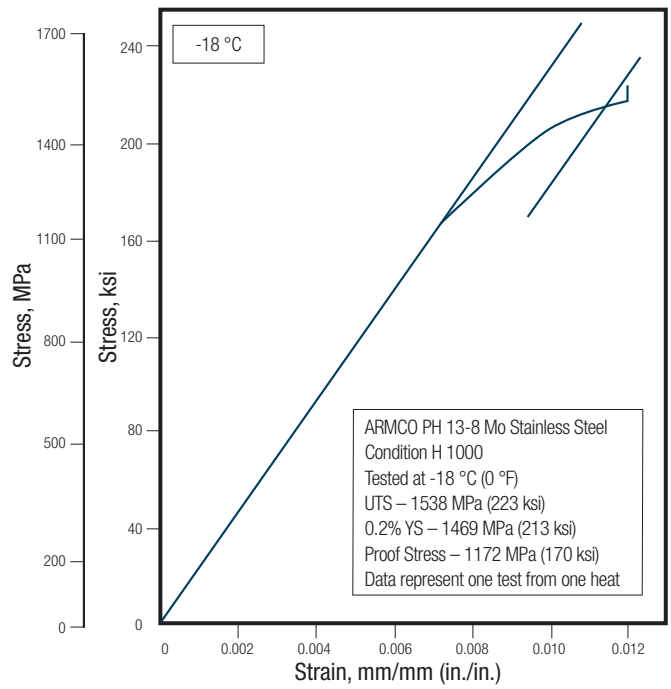
ARMCO® PH 13-8 Mo STAINLESS STEEL

Stress-Strain Curves

**FIGURE 13 – EFFECT OF TEST TEMPERATURE ON  
CONDITION H 1000 – TENSION**



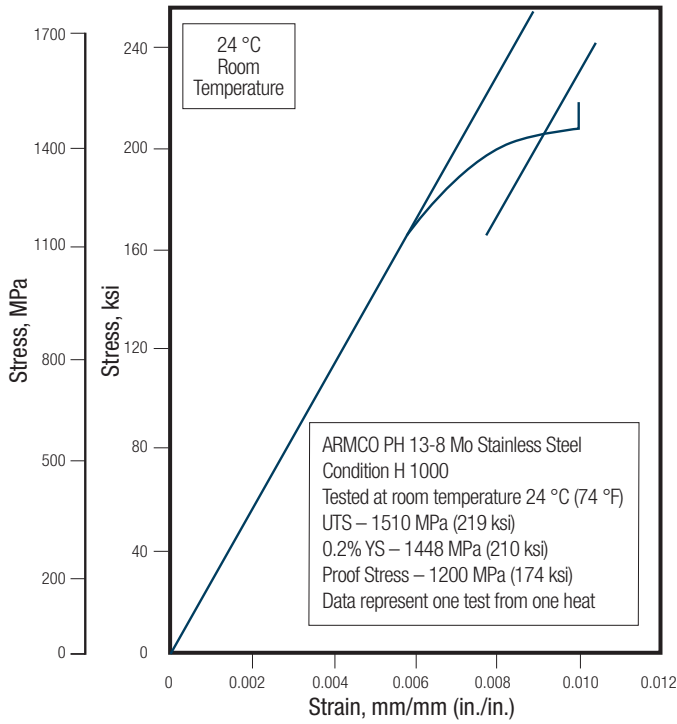
**FIGURE 14 – EFFECT OF TEST TEMPERATURE ON  
CONDITION H 1000 – TENSION**



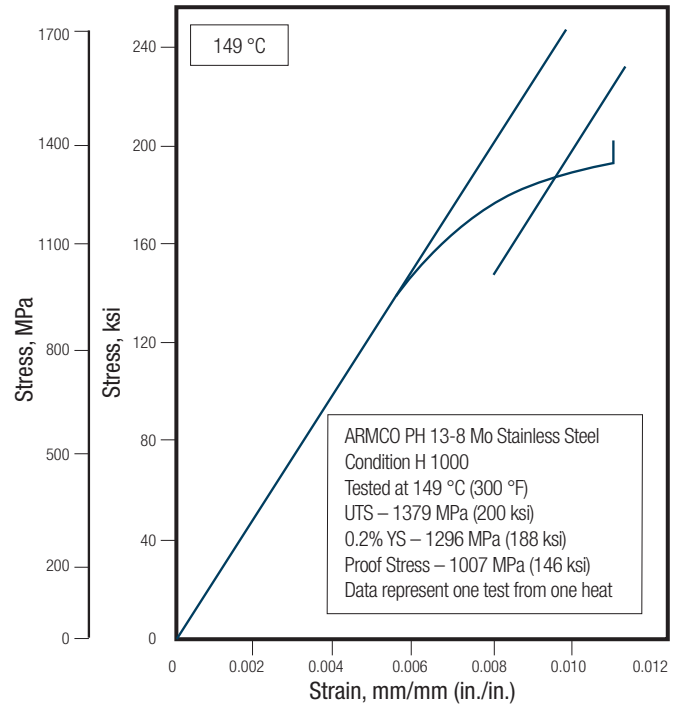
ARMCO® PH 13-8 Mo STAINLESS STEEL

Stress-Strain Curves

**FIGURE 15 – EFFECT OF TEST TEMPERATURE ON CONDITION H 1000 – TENSION**



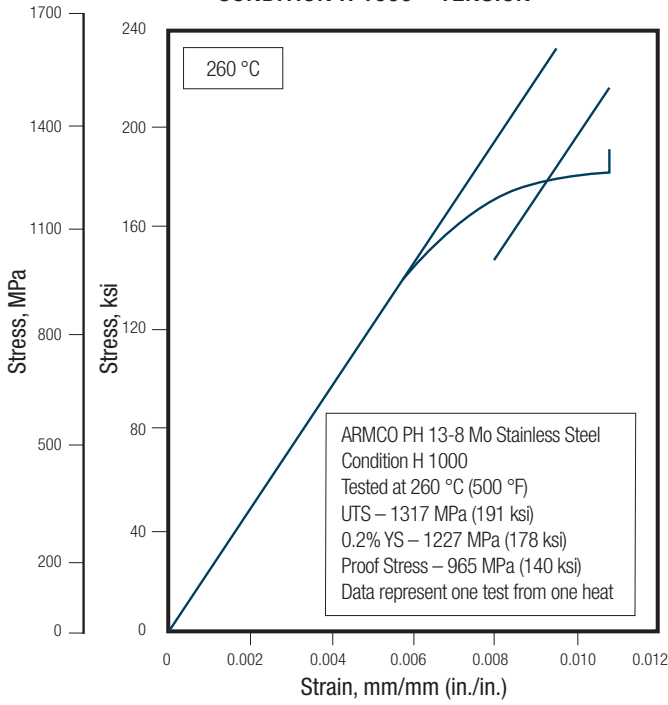
**FIGURE 16 – EFFECT OF TEST TEMPERATURE ON CONDITION H 1000 – TENSION**



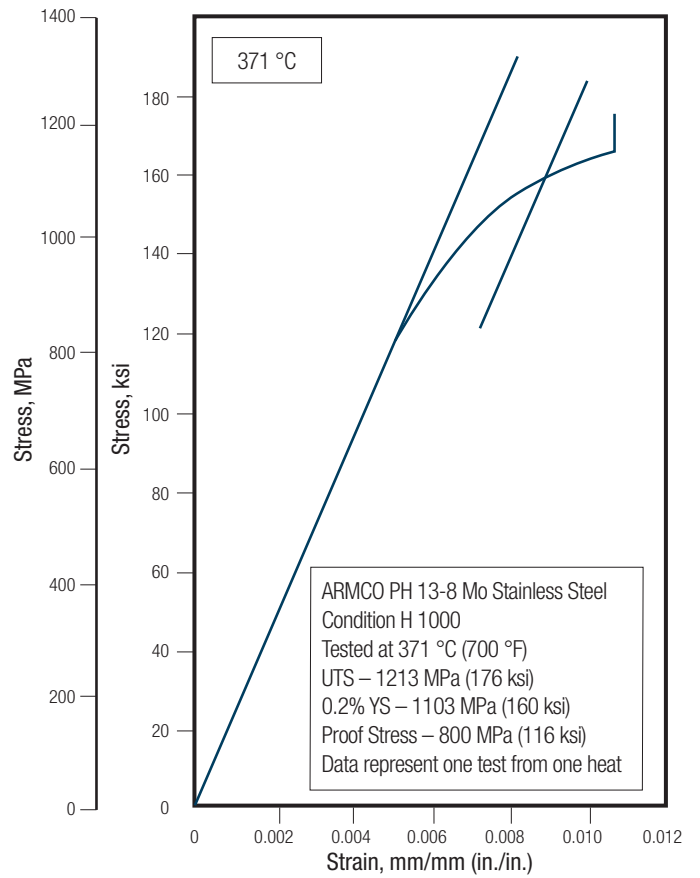
# ARMCO® PH 13-8 Mo STAINLESS STEEL

## Stress-Strain Curves

**FIGURE 17 – EFFECT OF TEST TEMPERATURE ON  
CONDITION H 1000 – TENSION**



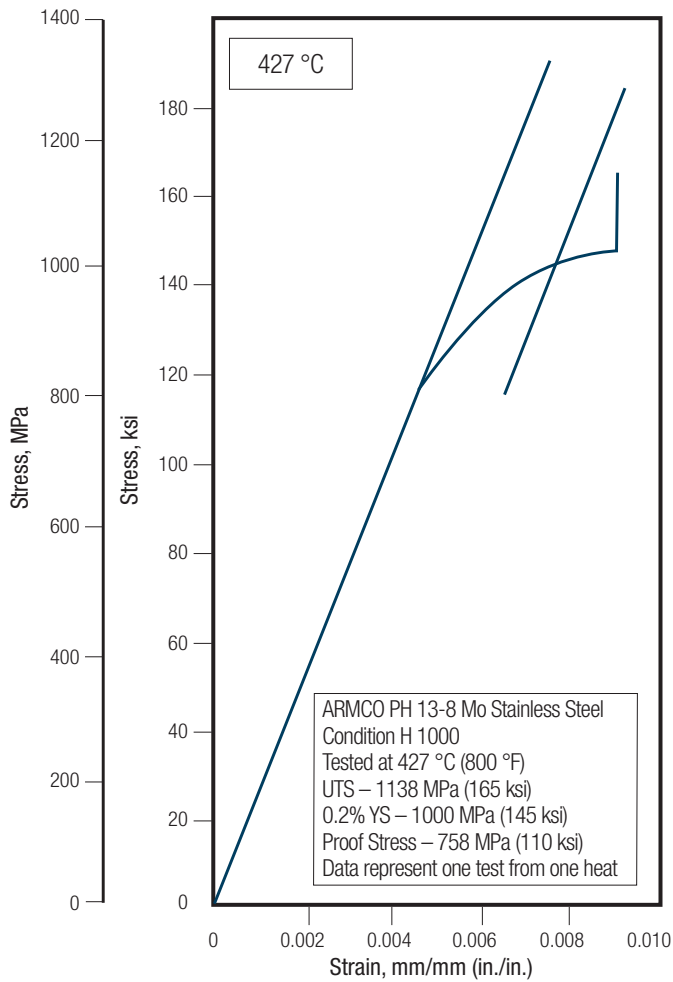
**FIGURE 18 – EFFECT OF TEST TEMPERATURE ON  
CONDITION H 1000 – TENSION**



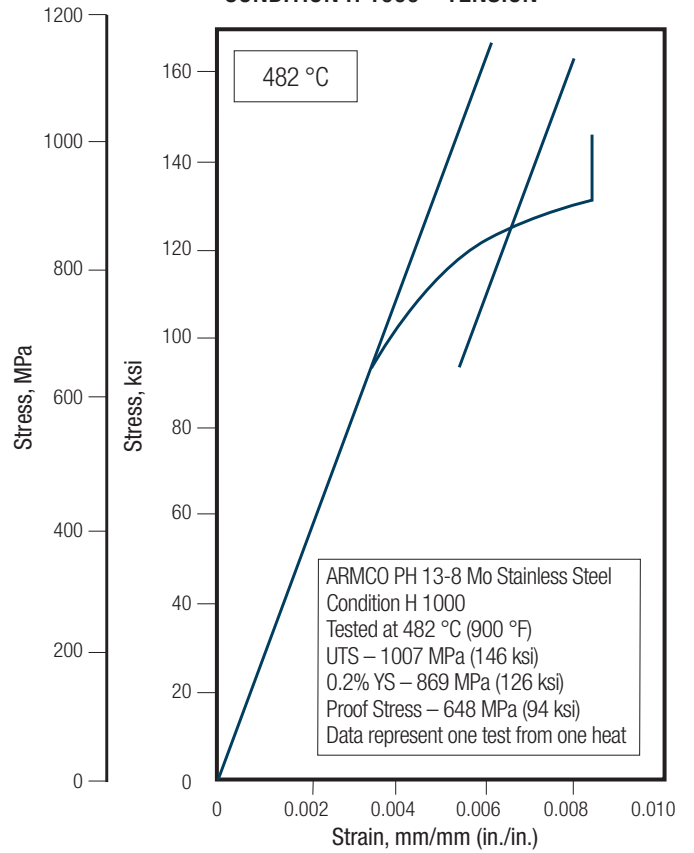
ARMCO® PH 13-8 Mo STAINLESS STEEL

Stress-Strain Curves

**FIGURE 19 – EFFECT OF TEST TEMPERATURE ON  
CONDITION H 1000 – TENSION**



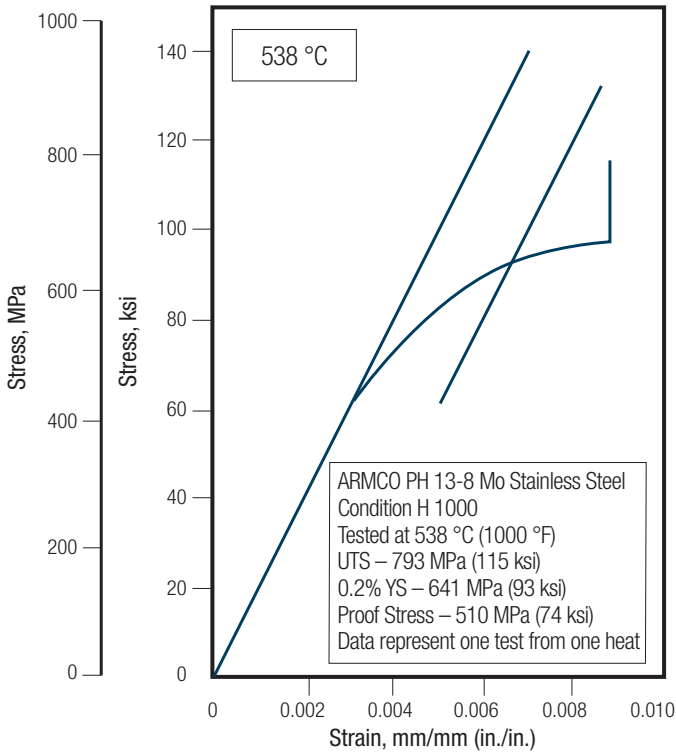
**FIGURE 20 – EFFECT OF TEST TEMPERATURE ON  
CONDITION H 1000 – TENSION**



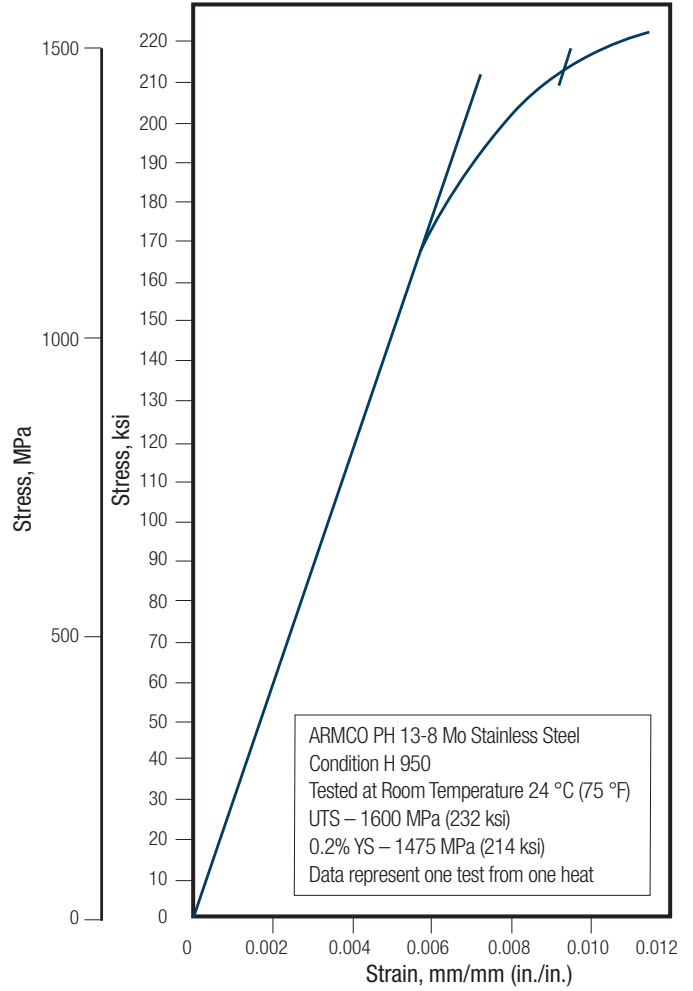
ARMCO® PH 13-8 Mo STAINLESS STEEL

Stress-Strain Curves

**FIGURE 21 – EFFECT OF TEST TEMPERATURE ON CONDITION H 1000 – TENSION**



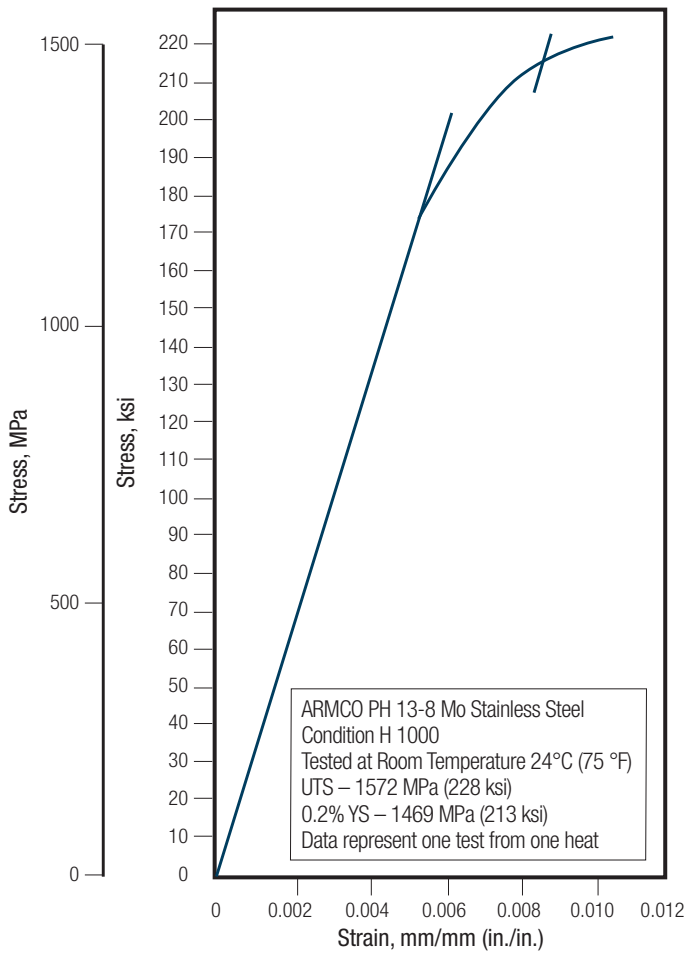
**FIGURE 22 – EFFECT OF VARIOUS HEAT-TREATED CONDITIONS ON ROOM TEMPERATURE CURVES**



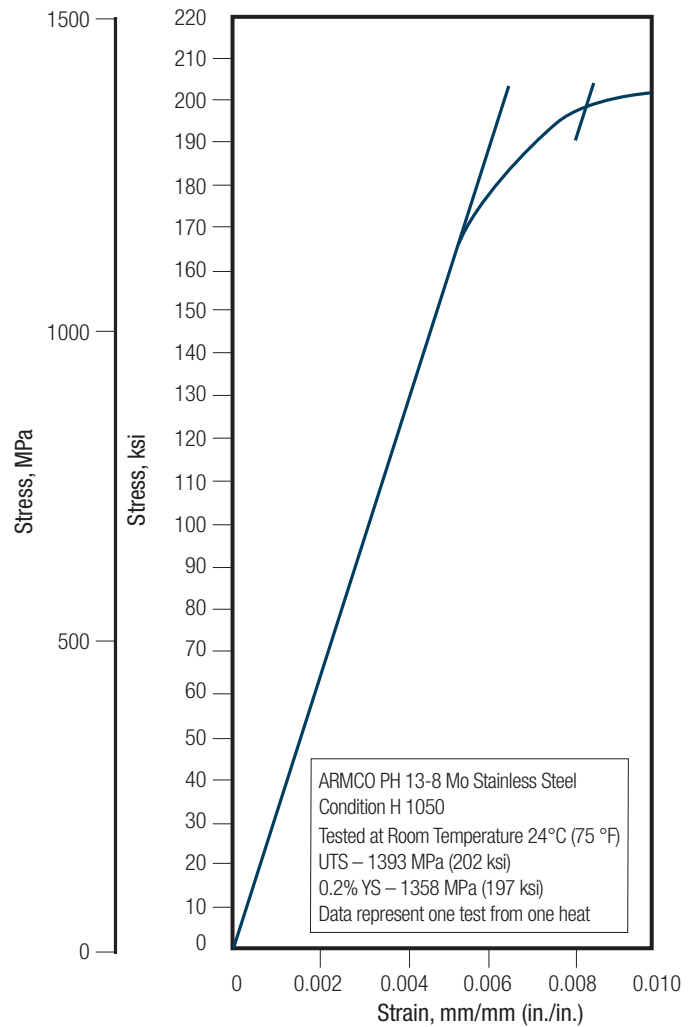
ARMCO® PH 13-8 Mo STAINLESS STEEL

Stress-Strain Curves

**FIGURE 23 – EFFECT OF VARIOUS HEAT-TREATED CONDITIONS ON ROOM TEMPERATURE CURVES – TENSION**



**FIGURE 24 – EFFECT OF VARIOUS HEAT-TREATED CONDITIONS ON ROOM TEMPERATURE CURVES – TENSION**



ARMCO® PH 13-8 Mo STAINLESS STEEL

Stress-Strain Curves

FIGURE 25 – EFFECT OF VARIOUS HEAT-TREATED CONDITIONS ON ROOM TEMPERATURE CURVES – TENSION

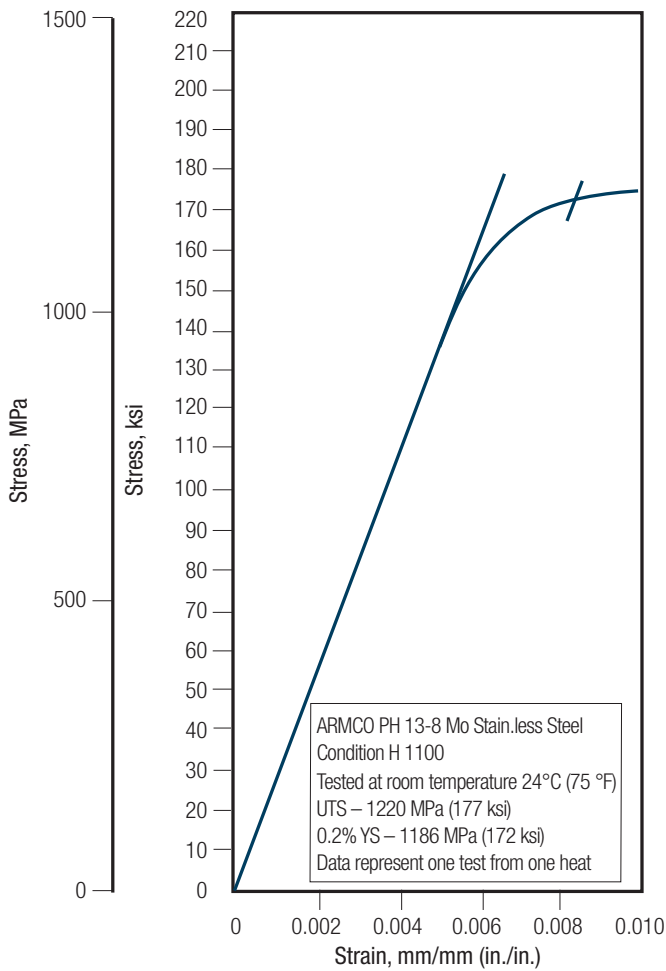
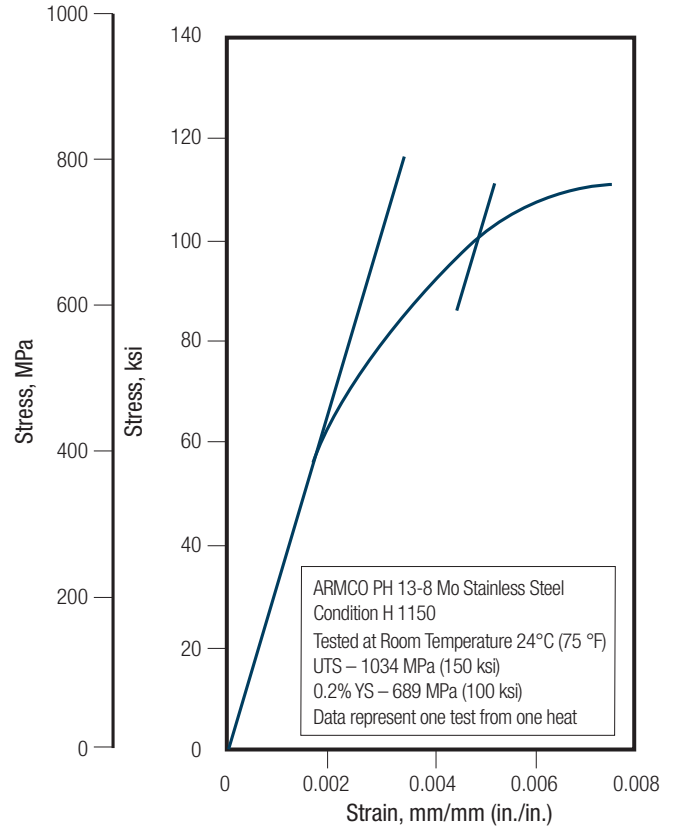


FIGURE 26 – EFFECT OF VARIOUS HEAT-TREATED CONDITIONS ON ROOM TEMPERATURE CURVES – TENSION

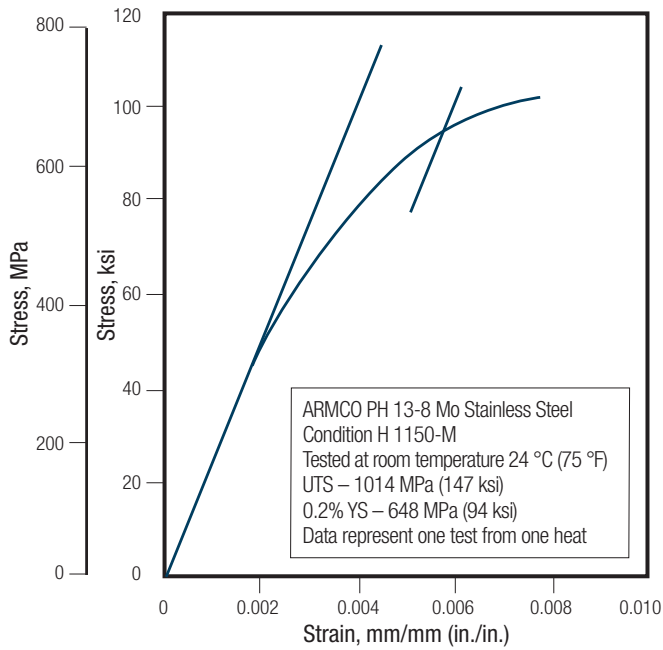




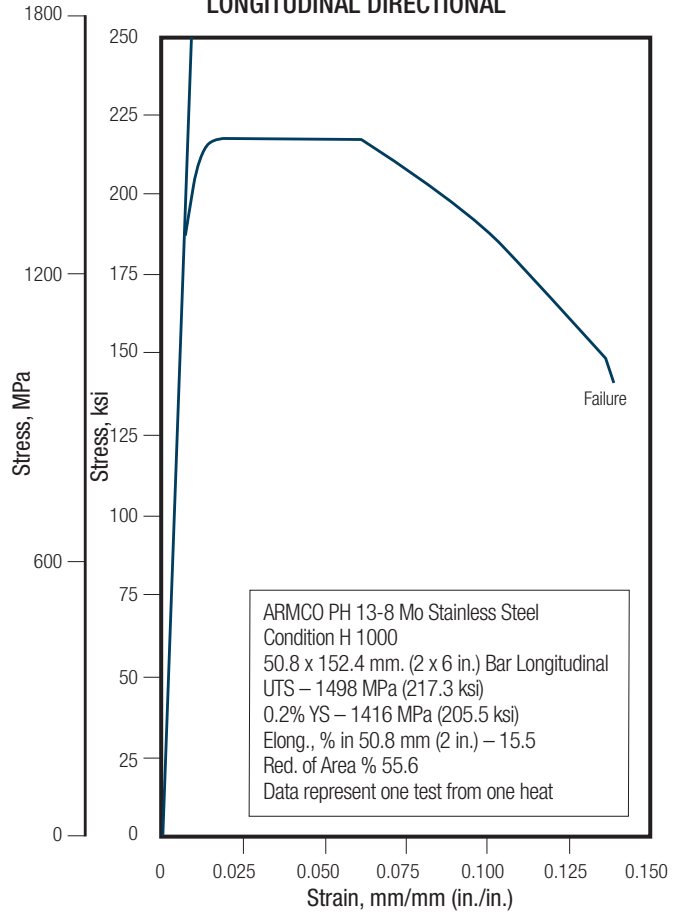
# ARMCO® PH 13-8 Mo STAINLESS STEEL

## Stress-Strain Curves

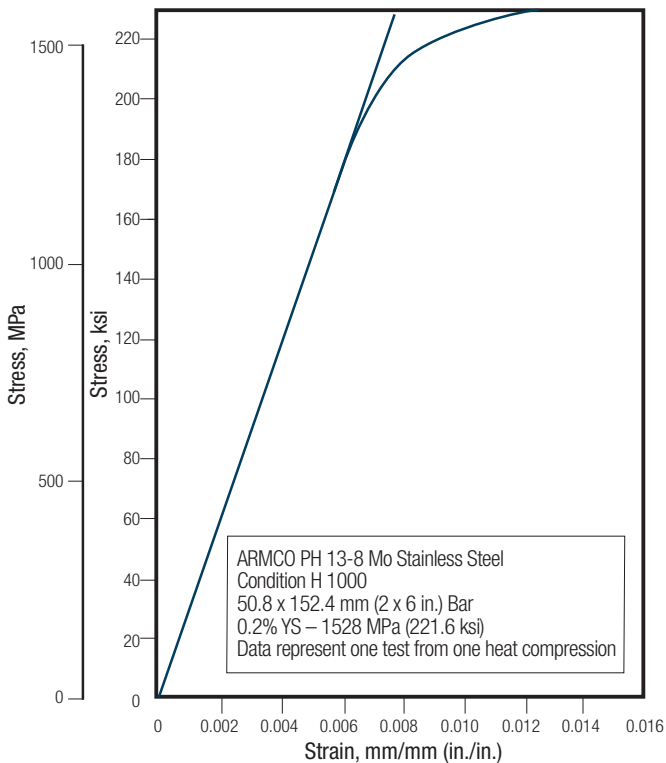
**FIGURE 27 – EFFECT OF VARIOUS HEAT-TREATED CONDITIONS ON ROOM TEMPERATURE CURVES – TENSION**



**FIGURE 29 – TOTAL STRESS-STRAIN CURVES H1000 LONGITUDINAL DIRECTIONAL**



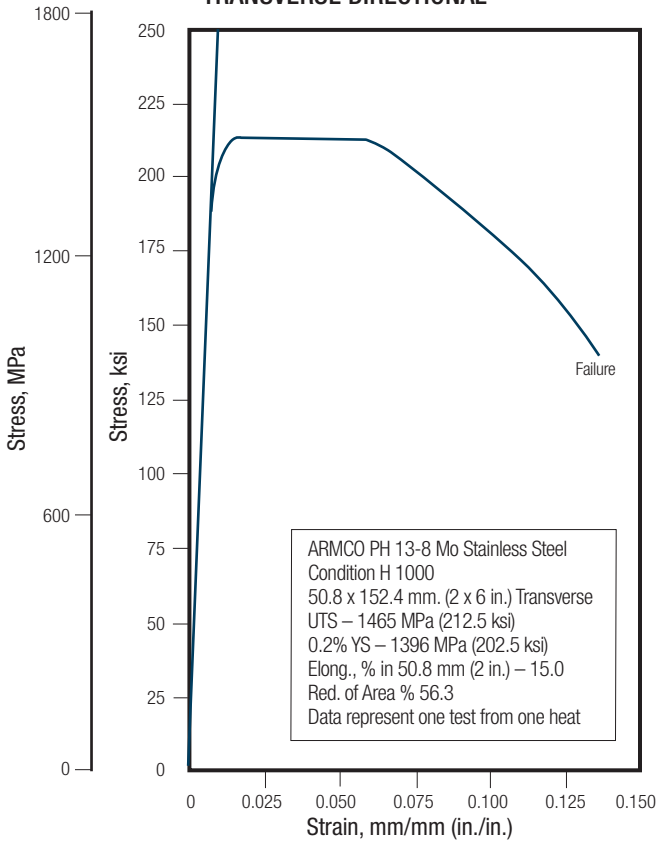
**FIGURE 28 – COMPRESSION STRESS – STRAIN CURVE**



# ARMCO® PH 13-8 Mo STAINLESS STEEL

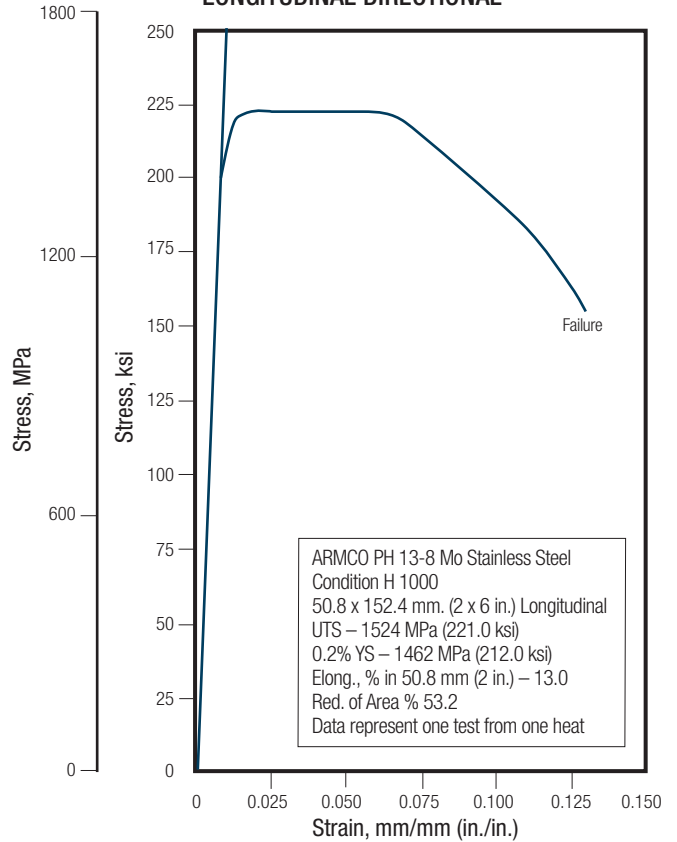
## Stress-Strain Curves

**FIGURE 30 – TOTAL STRESS-STRAIN CURVES H1000  
TRANSVERSE DIRECTIONAL**



Note: Identical test to Figure 29, performed on a different heat.

**FIGURE 31 – TOTAL STRESS-STRAIN CURVES H1000  
LONGITUDINAL DIRECTIONAL**



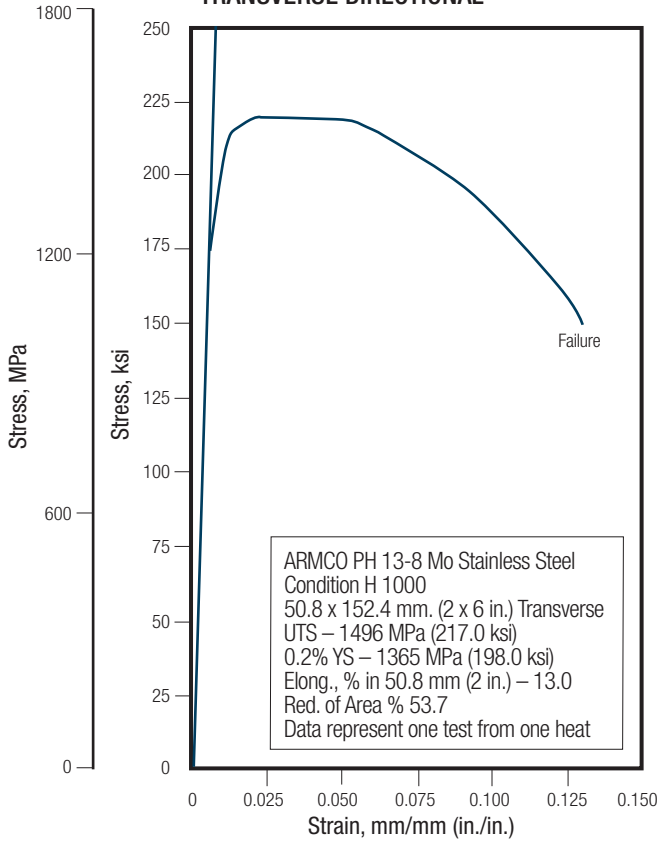
Note: Identical test to Figure 29, performed on a different heat.



ARMCO® PH 13-8 Mo STAINLESS STEEL

Stress-Strain Curves

**FIGURE 32 – TOTAL STRESS-STRAIN CURVES H1000  
TRANSVERSE DIRECTIONAL**



Note: Identical test to Figure 30, performed on a different heat.

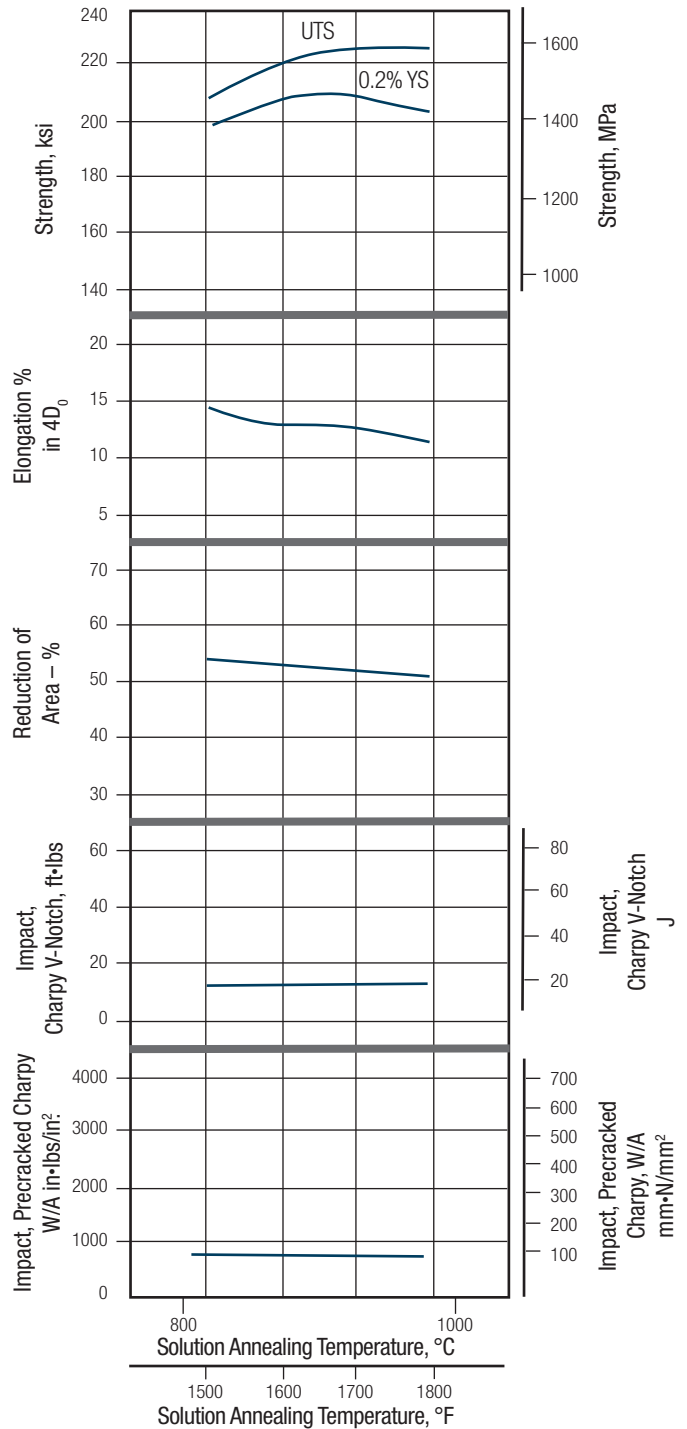
# ARMCO® PH 13-8 Mo STAINLESS STEEL

## Variations in Heat Treatment

### EFFECT OF VARIATIONS IN HEAT TREATMENTS

Figure 33 shows the effect of variation in solution treatment. These are useful in predicting the behavior of ARMCO PH 13-8 Mo Stainless Steel in brazing cycle and other multiple-cycle heat treatments.

**FIGURE 33 – EFFECT OF VARIATION IN SOLUTION TREATMENT\* CONDITION H 950**



\*Tested in transverse direction 75 x 169 mm (3 x 6.75 in.) section. Duplicate tests from one heat.



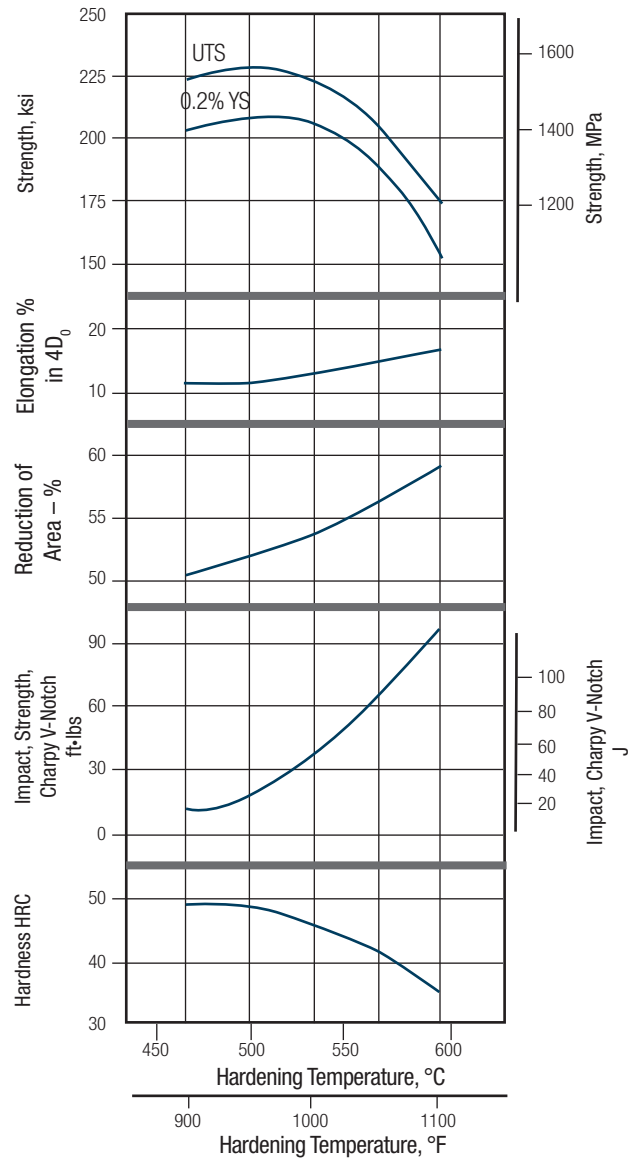
# ARMCO® PH 13-8 Mo STAINLESS STEEL

## Variations in Heat Treatment

### EFFECT OF HARDENING TREATMENTS ON SOLUTION-ANNEALED BAR

As with other precipitation hardening stainless steels, increasing the aging temperature increases ductility and toughness with corresponding drop in strength and hardness.

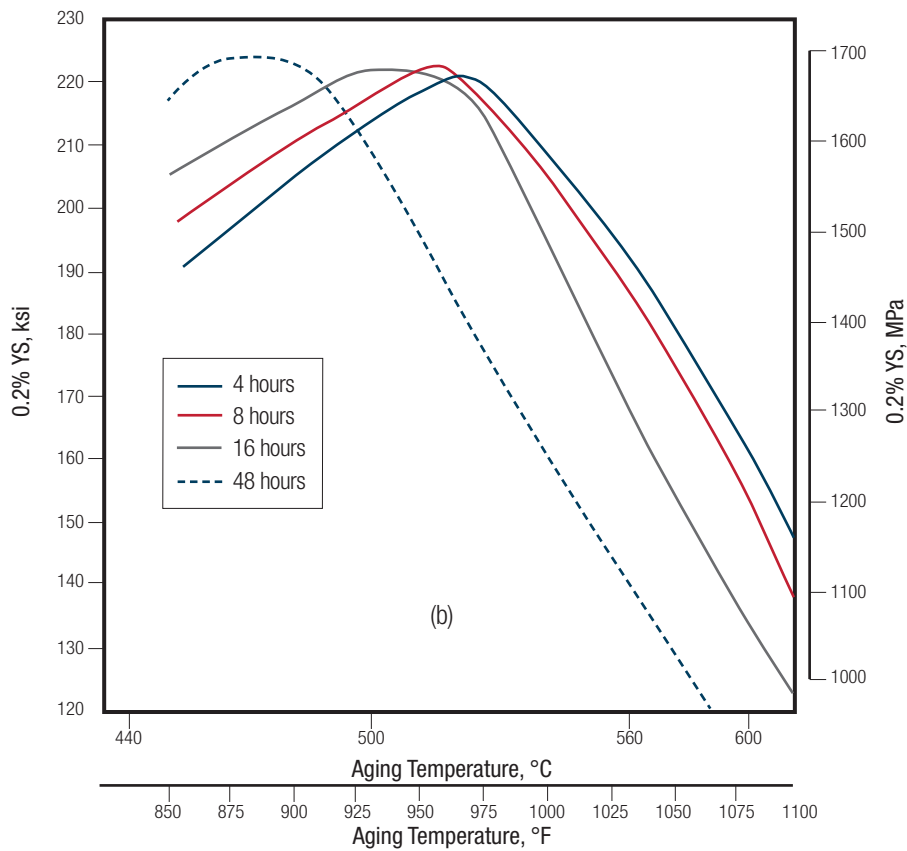
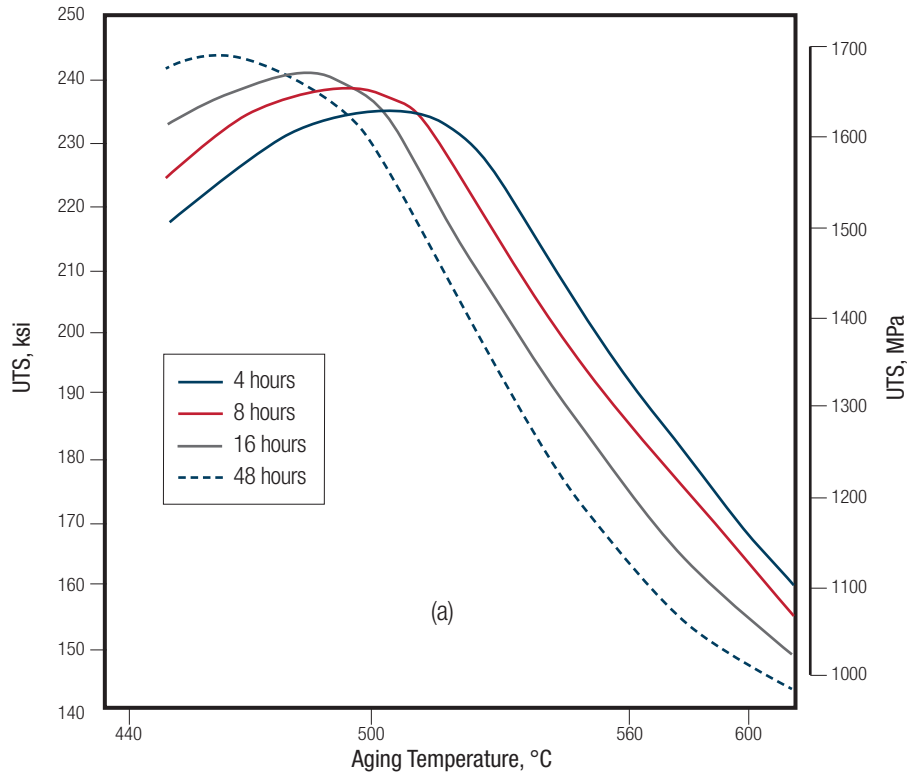
**FIGURE 34 – 4 HR. HARDENING TIME, EFFECT OF VARIATION OF HARDENING TEMPERATURE\***



\*Constructed from data representing duplicate tests from one heat.

## Variations in Heat Treatment

**FIGURE 35 – TENSILE STRENGTH VS. HARDENING TEMPERATURE**



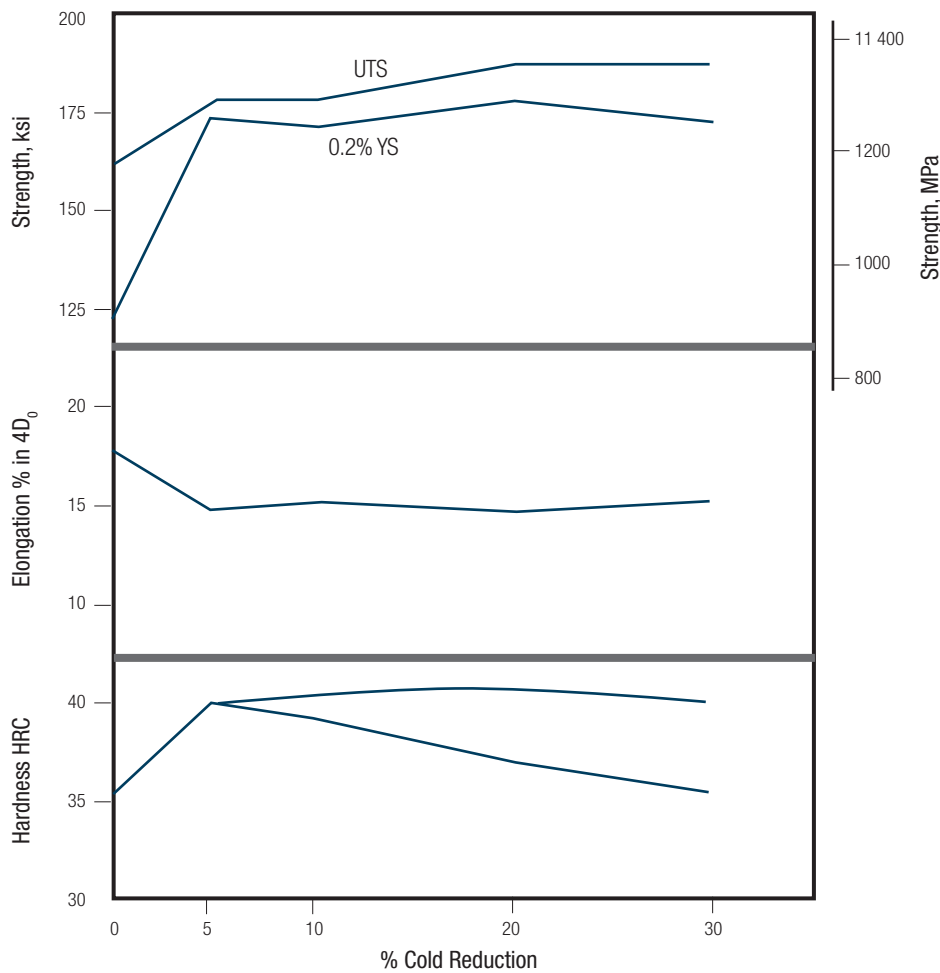
# ARMCO® PH 13-8 Mo STAINLESS STEEL

## Variations in Heat Treatment

### EFFECT OF COLD WORK AND COLD WORK PLUS AGING

ARMCO PH 13-8 Mo Stainless Steel produces highest strength levels when it is cold worked prior to precipitation hardening. Figure 36 is presented to facilitate handling of cold worked bar before it is precipitation hardened to the full strength level.

**FIGURE 36 – EFFECT OF COLD WORK ON SOLUTION-TREATED PROPERTIES\***



Data developed on 19 mm (0.75 in.) round bar stock – duplicate from one heat.

\*Fabrication sequence:

- 1) Solution Annealing
- 2) Cold Drawing

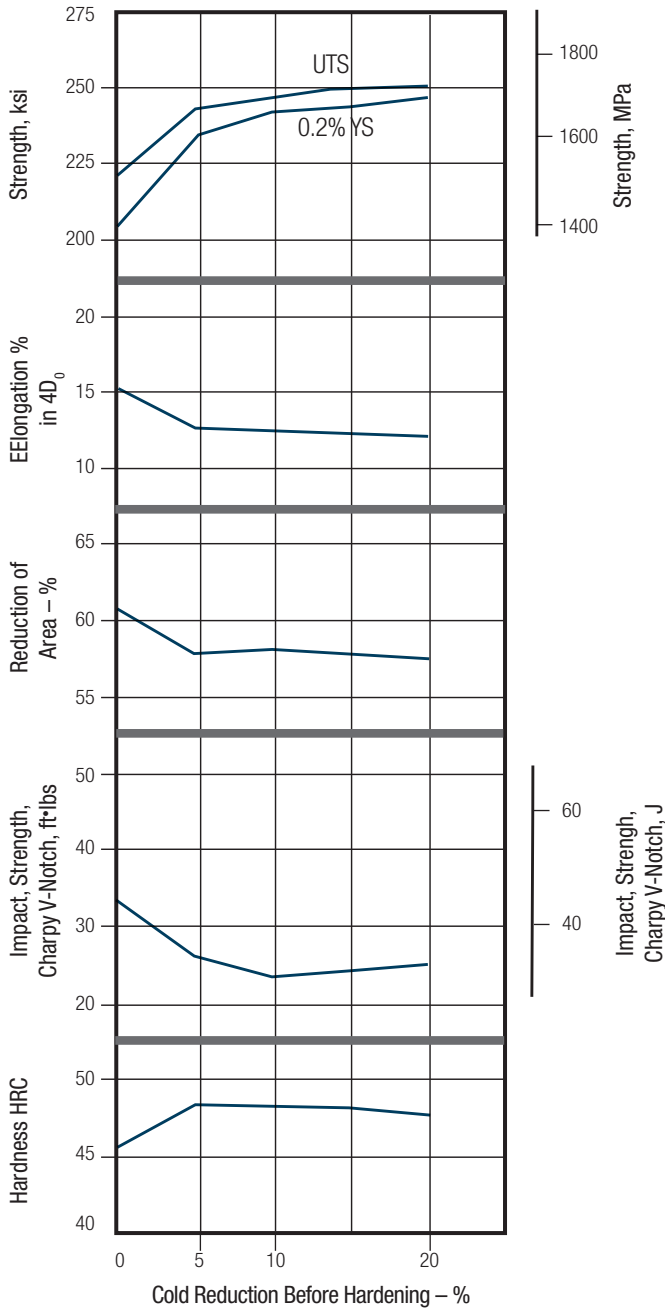
# ARMCO® PH 13-8 Mo STAINLESS STEEL

## Variations in Heat Treatment

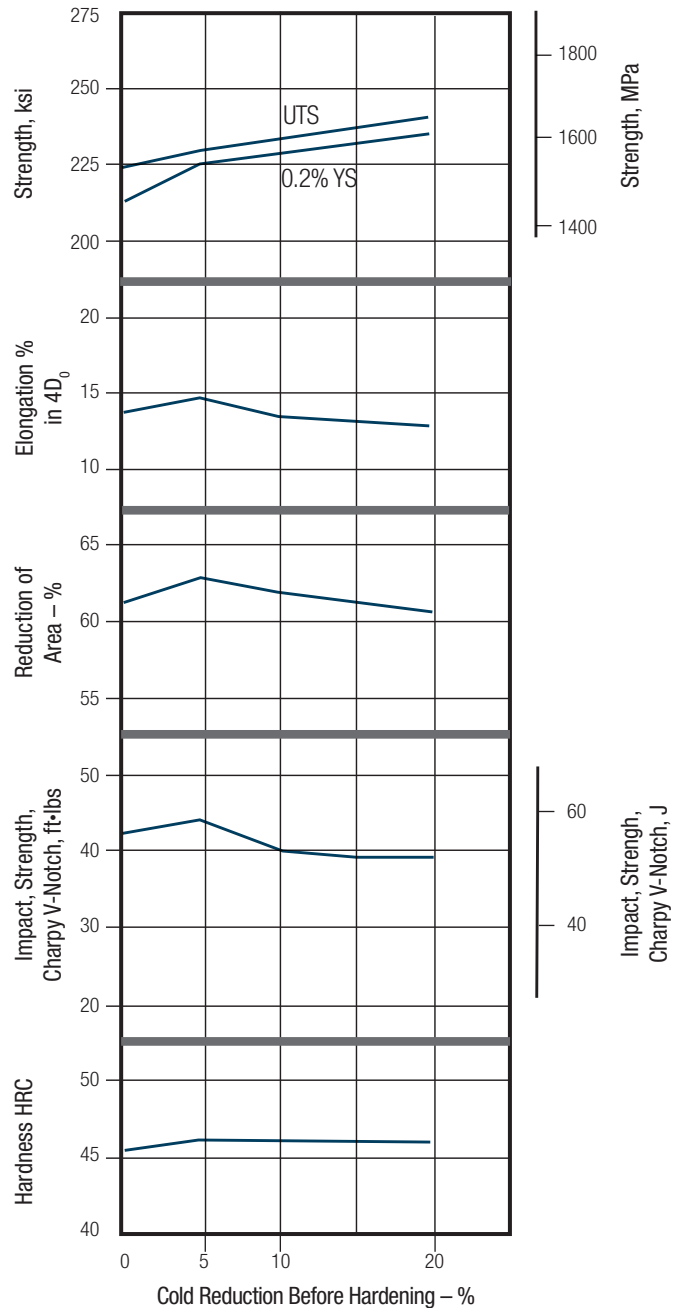
### EFFECT OF % COLD WORK ON FINAL PROPERTIES OF COLD WORKED AND HEAT TREATED BARS\*

Figures 37, 38, 39 and 40 constructed from data representing duplicate tests from one heat.

**FIGURE 37 – 482 °C (900 °F) HARDENING TEMPERATURE**



**FIGURE 38 – 538 °C (1000 °F) HARDENING TEMPERATURE**



\*Fabrication Sequence  
 (1) Solution Treat  
 (2) Cold Work  
 (3) Precipitation Harden 4 Hours



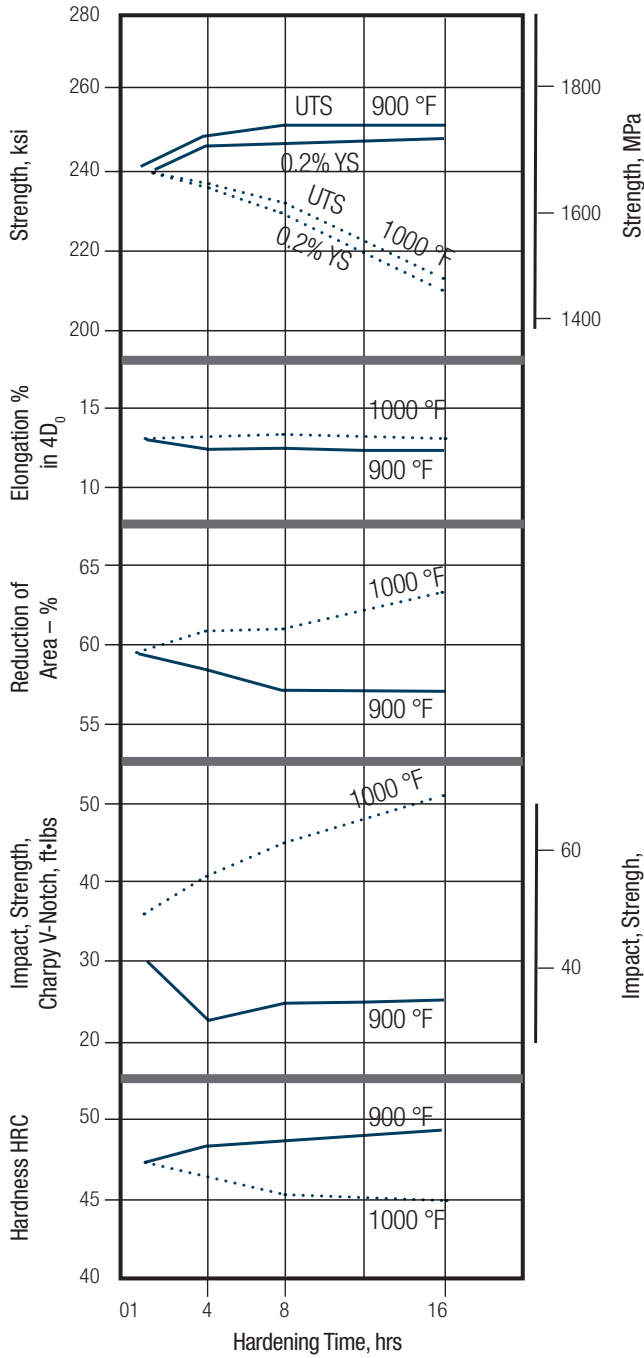


# ARMCO® PH 13-8 Mo STAINLESS STEEL

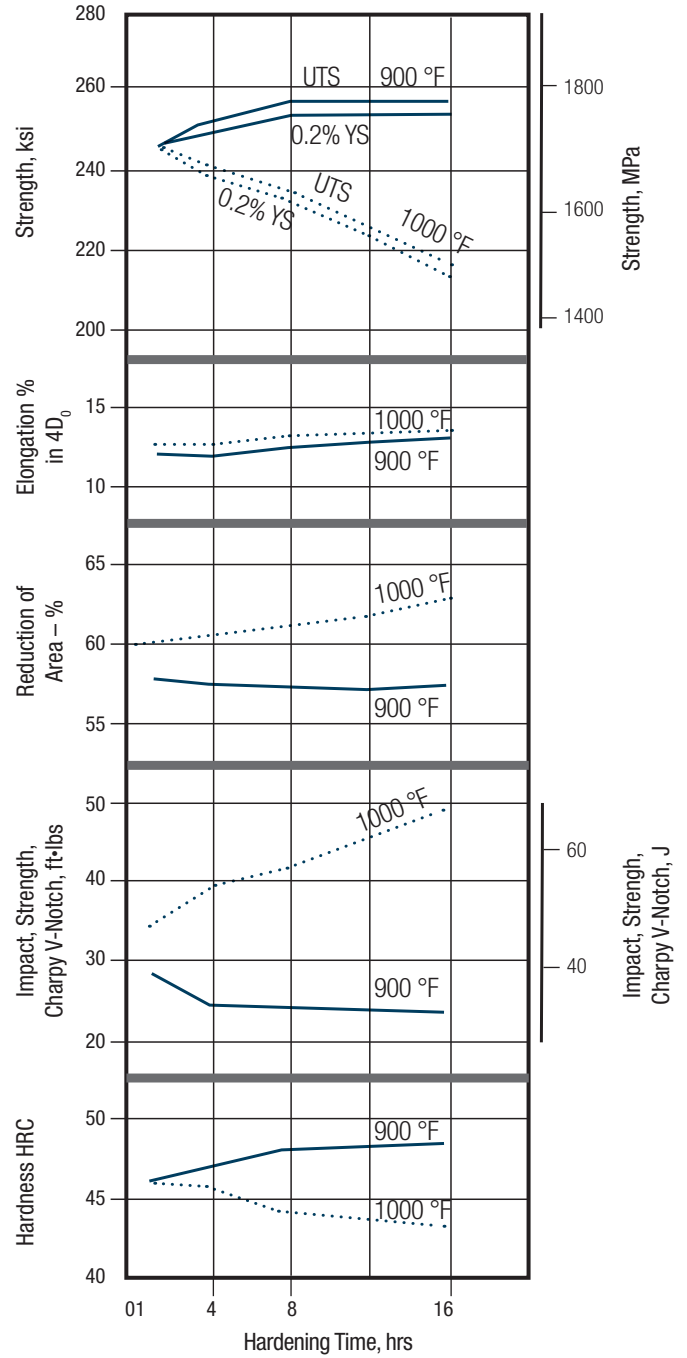
## Variations in Heat Treatment

EFFECT OF HARDENING TIME AND TEMPERATURE ON COLD REDUCED BARS UP TO 19 mm (0.75 in.) DIAMETER

**FIGURE 39 – COLD REDUCED 10%**



**FIGURE 40 – COLD REDUCED 20%**



# ARMCO® PH 13-8 Mo STAINLESS STEEL

## Physical Properties

The following data represent single tests from one heat.

**TABLE 15 – DENSITY**

Condition	Density		
	kg/m <sup>3</sup>	g/cm <sup>3</sup>	lbs/in <sup>3</sup>
A	7740	7.74	0.279
H 1000	7760	7.76	0.279

**TABLE 16 – DIMENSIONAL CHANGE ON HEAT TREATMENT FROM CONDITION A**

On hardening ARMCO PH 13-8 Mo Stainless Steel, a predictable dimensional contraction will occur. Contractions for various hardening temperatures are indicated in the following table.

Hardening Temperature, °C (°F)	Contraction*, mm/mm (= in./in.)
510 (950)	0.0004 – 0.0006
538 (1000)	0.0004 – 0.0006
566 (1050)	0.0005 – 0.0008
593 (1100)	0.0008 – 0.0012
621 (1150)	0.0030
760 + 621 (1400 + 1150)	0.0035

\*Samples in Condition A prior to heat treatment.

**TABLE 17 – MODULUS OF ELASTICITY**

The Modulus of Elasticity for ARMCO PH 13-8 Mo stainless steel is:

Condition	Modulus of Elasticity, GPa (Mpsi)	μ
H 950	*202 (29.4)	–
H 1000	*202 (29.4)	–
H 1050	*202 (29.4)	–
H 1000	**194 (28.3)	0.278

\*Determined from Compression Test.

\*\*Determined from Tension Test.

**TABLE 18 – THERMAL CONDUCTIVITY AND ELECTRICAL RESISTIVITY (CONDITION A)**

Temperature, °C (°F)	Thermal Conductivity, W/m·K (BTU/hr/ft <sup>2</sup> /in./°F)	Electrical Resistivity, μΩ·cm
25 (77)	–	100.1
100 (212)	14.0 (97.1)	101.9
200 (392)	15.8 (109.6)	104.6
315 (599)	17.9 (124.1)	106.1
425 (797)	20.5 (142.2)	108.1
540 (1004)	22.0 (152.6)	109.1
600 (1112)	22.6 (156.7)	109.5



# ARMCO® PH 13-8 Mo STAINLESS STEEL

## Physical Properties

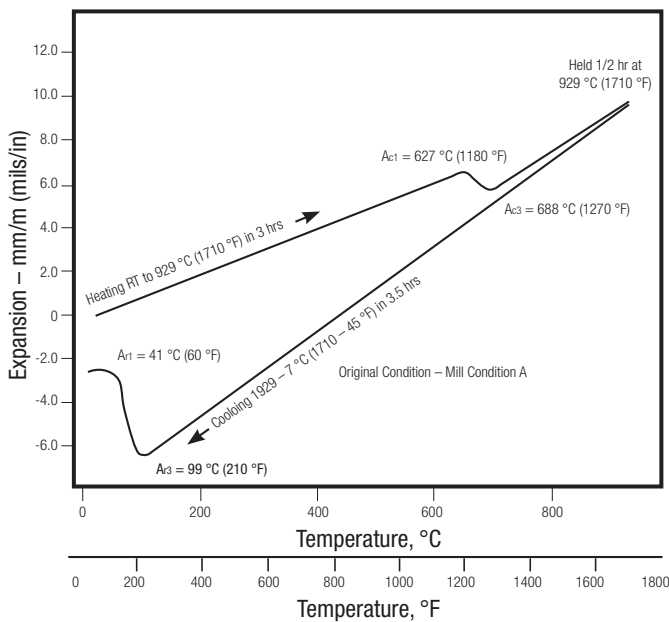
TABLE 19 – MEAN COEFFICIENT OF THERMAL EXPANSION  $\mu\text{m}/\text{m}\cdot^{\circ}\text{C}$  ( $\mu\text{in.}/\text{in.}/^{\circ}\text{F}$ )

Temperature Range. $^{\circ}\text{C}$ ( $^{\circ}\text{F}$ )	Condition			
	H 950	H 1000	H 1050	H 1100
21 – 93 (70 – 200)	10.6 (5.9)	10.4 (5.8)	10.4 (5.8)	10.8 (6.0)
21 – 204 (70 – 400)	10.8 (6.0)	10.8 (6.0)	10.6 (5.9)	11.3 (6.3)
21 – 316 (70 – 600)	11.2 (6.2)	11.2 (6.2)	11.2 (6.2)	11.5 (6.4)
21 – 427 (70 – 800)	11.3 (6.3)	11.3 (6.3)	11.3 (6.3)	11.7 (6.5)
21 – 538 (70 – 1000)	11.9 (6.6)	11.9 (6.6)	11.9 (6.6)	12.2 (6.8)

### DIMENSIONAL STABILITY

The following dilatometer curve is shown to indicate thermal expansion and contraction as well as transformation temperatures in ARMCO PH 13-8 Mo Stainless Steel.

FIGURE 41 – DILATOMETER CURVE



ARMCO® PH 13-8 Mo STAINLESS STEEL

Magnetic Permeability

FIGURE 42 – NORMAL INDUCTION – ARMCO PH 13-8 Mo STAINLESS STEEL – CONDITION H 950

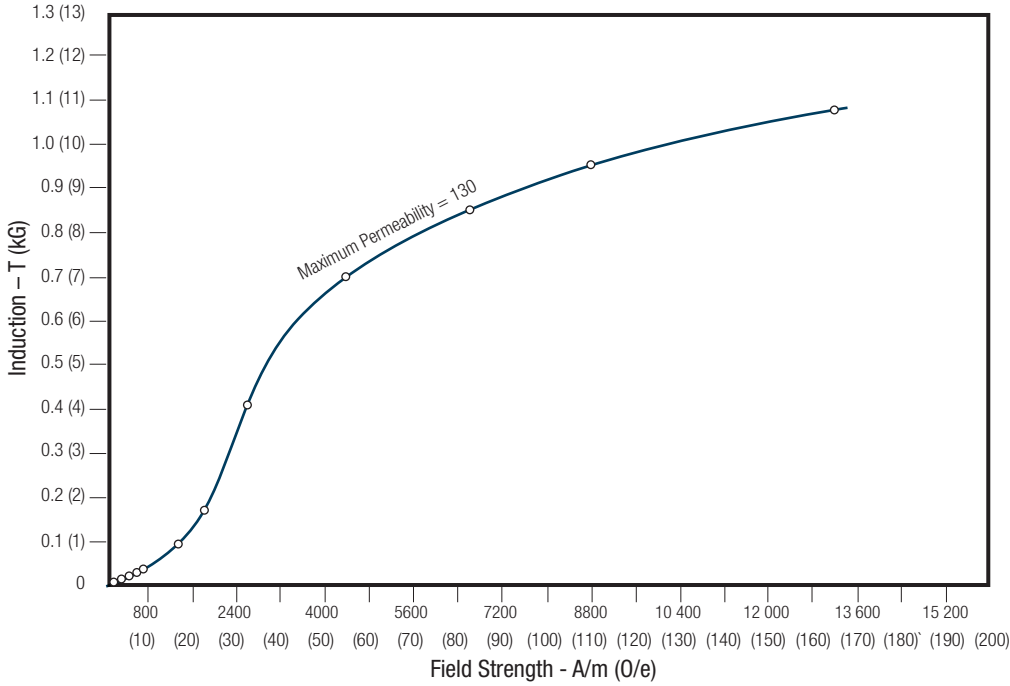
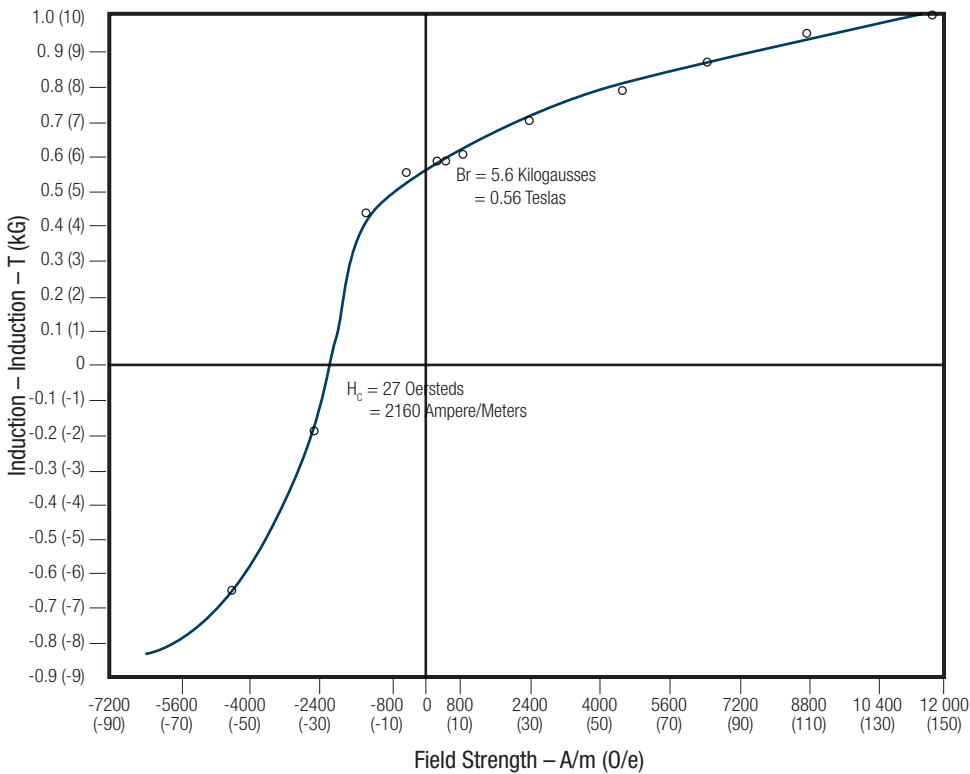


FIGURE 43 – HYSTERESIS CURVE – ARMCO PH 13-8 Mo STAINLESS STEEL – CONDITION H 950



# ARMCO® PH 13-8 Mo STAINLESS STEEL

## Fabrication

### HEAT TREATMENT

When hot working, welding, brazing or applying other treatments altering the metallurgical structure of ARMCO PH 13-8 Mo Stainless Steel, it is necessary to re-solution heat treat to obtain full design properties in the fabricated parts.

The removal of oils and coatings as well as paint, soft makings and stickers/labels prior to heat treatment is essential to avoid contamination. Carburized, nitrided or otherwise contaminated parts do not respond fully to heat treatment.

While selection of heat treating equipment depends to some extent upon the parts to be heat treated, heat source, atmosphere and control of temperature are the primary considerations.

Furnaces fired with oil or natural gas are not entirely satisfactory for the heat treatment of stainless steels. In such units it is difficult to control combustion and eliminate flame impingement on the parts being treated. Electric furnaces or gas-fired radiant tube furnaces are generally used for heat treating precipitation hardening stainless steels, including ARMCO PH 13-8 Mo Stainless Steel.

Air has proved to be a satisfactory furnace atmosphere for solution-treating and hardening operations. Controlled reducing atmospheres such as dissociated ammonia or bright annealing gas introduce the hazard of nitriding and carburizing or decarburizing. All of these surface conditions result in significantly lower strength in the affected areas. Bright solution treating may be accomplished in hydrogen, argon or helium atmospheres (dew point of -53 °C [-65 °F] or lower) or vacuum. Such atmospheres will provide an essentially scale-free surface if a cooling rate approximately that of an air cool can be obtained.

Solution heat treatment (927 °C 1700 °F) in molten salts is not recommended because of the danger of carburization and/or intergranular penetration.

### IMPORTANCE OF COOLING TO 16 °C (60 °F) IN FABRICATION AND HEAT TREATING ARMCO PH 13-8 Mo STAINLESS STEEL

In fabricating ARMCO PH 13-8 Mo Stainless Steel it is important to keep in mind the low temperatures at which the start of transformation to martensite ( $M_s$ ) and the finish of the martensite transformation ( $M_f$ ) occur. These temperatures are approximately 121 °C (250 °F) and 21 °C (70 °F), respectively.

Because of this unusual characteristic, it is necessary to cool parts in process below 16 °C (60 °F) prior to applying subsequent heat treatments if normal final properties are to be obtained. This

practice is essential to assure grain refinement, and to make sure the product will have the good ductility you can expect of this alloy. Examples of situations where cooling below 16 °C (60 °F) is an important step follow:

- a) Cool below 16 °C (60 °F) after solution treating prior to applying any of the precipitation hardening treatments.
- b) Cool forged parts below 32 °C (90 °F) after final forging before solution treating.
- c) Cool any weldments below 32 °C (90 °F) prior to solution treating.

### DESCALING

The hardening treatments for ARMCO PH 13-8 Mo Stainless Steel produce only a light heat tint on the surfaces. The presence of this film may degrade the corrosion resistance of this alloy. It can be removed easily either by mechanical means, such as wet grit blasting, or by light pickling for several minutes in 10% nitric – 2% hydrofluoric acid (by volume) solution at 43 – 60 °C (110 – 140 °F). See Table 20, where pickling is undesirable, the heat tint may be removed by light electropolishing. The latter two treatments also passivate or clean the surfaces for maximum corrosion resistance.

When forging or solution heat treating is performed, the following pickling method has proven satisfactory. Use of scale softening methods such as molten sodium hydride or the Virgo process is limited since these methods harden solution-annealed material.

In pickling operations, close control of time and temperature is necessary to obtain uniform scale removal without over-etching.

The most satisfactory method of removing scale resulting from solution heat treatment or from forging has been grit blasting. Scale softening methods may be used on material that has been solution annealed (not pickled) and precipitation hardened.

TABLE 20 – CLEANING AND PICKLING STEPS

Procedure	Acid Bath	Temperature, °C (°F)	Time, Minutes	Rinse
Step 1	Caustic Permanganate	71 – 82 (160 – 180)	60	Water rinse
Step 2	10% Nitric Acid + 2% Hydrofluoric Acid	43 – 60 (110 – 140)	2 – 3	Hot water high pressure water or brush scrub

# ARMCO® PH 13-8 Mo STAINLESS STEEL

## Fabrication

### CUTTING

In general, the cutting procedures commonly used for standard chrome-nickel stainless steels have proven satisfactory for ARMCO PH 13-8 Mo Stainless Steel.

Cold sawing is suggested for cutting bars and forging billets. Hot cutting or abrasive wheel cutting with a large volume of coolant has been used successfully. However, it should be noted that if abrasive wheel cutting is not controlled, abrasive wheel cutting in Condition A can cause small cracks on the cut face.

Thermal cutting of ARMCO PH 13-8 Mo Stainless Steel requires a process suited for cutting stainless steel such as flux-injection, powder cutting, oxy-arc or arc-air methods. Since the heat-affected zones of ARMCO PH 13-8 Mo Stainless Steel are not significantly hardened or embrittled by the localized heat of welding or torch cutting, this alloy offers good possibilities for cutting by use of a thermal process.

### FORGING

Forging has been an excellent method for forming intricate shapes of ARMCO PH 13-8 Mo Stainless Steel. Forging blanks should be heated uniformly to 1176 – 1204 °C (2150 – 2200 °F) and held at temperature for at least 15 minutes before forging. The last 50% of the hot reduction should be made below 1038 °C (1900 °F) in order to obtain best grain refinement when solution treated. On reheating, they should be soaked thoroughly. After forging, sections should be cooled to below 32 °C (90 °F) to assure grain refinement. Then, to obtain the best condition for the hardening operations, the parts must be re-solution heat treated to Condition A. In heating for forging, as in the heat treatment of ARMCO PH 13-8 Mo Stainless Steel, the user is cautioned not to use endothermic atmospheres (or other atmospheres that may cause carburization or decarburization).

### MACHINING

ARMCO PH 13-8 Mo Stainless Steel in Condition A has provided good tool life and surface finish when machined at speeds of 20 – 30% lower than those used for ARMCO 17-4 PH at similar hardness levels.

### WELDING

The composition of ARMCO PH 13-8 Mo Stainless Steel is balanced for optimum performance in welding. Low carbon content restricts the hardness of rapidly cooled material and avoids the formation of cracks in weld deposits and heat-affected zones of the base metal, eliminating the need for preheating. It also possesses sufficient ductility to permit welding in Condition A or in any heat-treated condition.

Weld fixtures and shielding for alignment, control of distortion and protection from air contaminants are similar to those employed for the conventional chromium and chromium-nickel stainless steels.

### FILLER METAL

The choice of a weld metal to join ARMCO PH 13-8 Mo Stainless Steel depends on properties required in the weld. Weld metal of PH 13-8 Mo composition is used where properties comparable to those of the base metal are desired. The weld metal can be produced by simple fusion of the base metal, but deposition of WPH 13-8 Mo filler wire is preferred. This holds the weld composition within established limits to provide good weld ductility in the hardened condition.

The microstructure of WPH 13-8 Mo weld metal at room temperature consists of a small amount of delta ferrite in a martensite matrix. Presence of delta ferrite in WPH 13-8 Mo weld metal is helpful in maintaining high immunity to hot cracking. A minimum of delta ferrite is also desired in this final heat treated weld structure to obtain good ductility in the hardened condition. The delta ferrite content is determined primarily by composition. Weld bead size also has some effect, with ferrite content being higher in the larger beads. Post-weld solution heat treatments decrease ferrite content.

**TABLE 21 – TOOLING AND LUBRICANTS – ARMCO PH 13-8 Mo**

Type of Work	Tooling	Lubricant
Low speed-high pressure (Milling, drilling)	High Speed Steel	High lubricity (Sulfur base oil)
High Speed (Turning)	Carbides (CISC C-6 and C-7)	Chemical coolant



# ARMCO® PH 13-8 Mo STAINLESS STEEL

## Fabrication

Austenitic chrome-nickel stainless steel weld metal may be used for joining ARMCO PH 13-8 Mo Stainless Steel where maximum strength is not needed in the weld joint. Such fillers provide a tough and ductile deposit in the joint, but the strength is only in the order of 620 MPa (90 ksi) ultimate tensile strength and 414 MPa (60 ksi) 0.2% yield strength. Filler metal of Type 308L is generally satisfactory.

If ARMCO PH 13-8 Mo Stainless Steel is to be joined to a dissimilar material, dilution must be considered. For example, in joining ARMCO PH 13-8 Mo Stainless Steel to a plain carbon or low alloy steel, Type 309 stainless would be employed. In other dissimilar metal joints when similar thermal expansion characteristics are needed, the use of a nickel base alloy weld metal is suggested.

### HEAT TREATMENT

In welds approximately 6 mm (0.25 in.) thick and under, both the weld deposit and heat-affected areas of the base metal will respond to the precipitation hardening heat treatment without the need for a post-weld solution anneal. Welds greater than 6 mm (0.25 in.) thick where multipass practices are employed will, if full properties are needed, necessitate the use of a post-weld anneal prior to precipitation hardening. If post-weld anneals are not feasible for the heavier sizes, the extent of response for any thickness can be anticipated by reference to data in the following tables.

**TABLE 22 – MECHANICAL PROPERTIES OF ARMCO PH 13-8 Mo STAINLESS STEEL WELDMENTS\* 4.7 mm (0.1875 in.) THICK PLATE**

Sample Condition	UTS, MPa (ksi)	0.2% YS, MPa (ksi)	Elong % in 31 mm (1.25")	Failed In
Unwelded Base Plate H 950	1517 (220)	1407 (204)	12	–
Weld + H 950	1483 (215)	1400 (203)	10	WM
Weld + Condition A + H 950	1490 (216)	1400 (203)	10	WM
Unwelded Base Plate H 1000	1476 (214)	1379 (200)	13	–
Weld + H 1000	1407 (204)	1372 (199)	11	WM
Weld + Condition A + H 1000	1386 (201)	1360 (197)	11	WM

\*Gas Tungsten Arc Welding (GTAW) process Base plate welded in Condition A WPH 13-8 Mo filler metal used. Average of duplicate tests from one heat.

# ARMCO® PH 13-8 Mo STAINLESS STEEL

## Fabrication

**TABLE 23 – MECHANICAL PROPERTIES OF ARMCO PH 13-8 Mo STAINLESS STEEL WELDMENTS\* 13 mm (0.5 in.) THICK PLATE**

Sample Condition	UTS, MPa (ksi)	0.2% YS, MPa (ksi)	Reduction of Area %	Elongation	
				% in 13 mm (0.5")	% in 31 mm (1.25") or 4D <sub>0</sub>
Unwelded Base Plate H 950	1600 (232)	1476 (214)	63	ND <sup>(1)</sup>	17
Weld + H 950	1427 (207)	1193 (173)	51	28	14
Weld + Condition A + H 950	1496 (217)	1400 (203)	26	BOG <sup>(2)</sup>	9
Unwelded Base Plate H 1000	1490 (216)	1448 (210)	65	ND <sup>(1)</sup>	17
Weld + H 1000	1379 (200)	1124 (163)	61	32	14
Weld + Condition A + H 1000	1448 (210)	1414 (205)	37	20	9
Unwelded Base Plate H 1100	1193 (173)	1124 (163)	71	ND	22
Weld + H 1 100	1138 (165)	855 (124)	71	38	18
Weld + Condition A + H 1100	1117 (162)	1089 (158)	29 <sup>(3)</sup>	18 <sup>(3)</sup>	8 <sup>(3)</sup>

\*Gas Tungsten Arc Welding (GTAW) process Samples welded in Condition A Filler metal WPH 13-8 Mo used Average of duplicate tests from one heat.

(1) ND – Not determined

(2) BOG – Broke outside gage

(3) Low values resulted from incomplete penetration in weld.

For most corrosive applications, the welded plus precipitation hardened conditions are satisfactory. Where weldments are to be exposed in strong oxidizing acid or marine environments, the use of a post-weld solution anneal prior to precipitation hardening is suggested.

### WELDING PROCESSES

The weld process most widely used for joining ARMCO PH 13-8 Mo Stainless Steel is Gas Tungsten Arc Welding (GTAW). The preferred shielding gas is helium. Both automated and manual practices have been used. Where increased wire feed rates are needed, hot wire filler additions may be employed. The plasma-arc and electron-beam weld processes, either with or without the addition of a filler, may also be employed.

The gas metal arc and shielded metal arc processes may be employed where chromium-nickel or nickel base fillers are to be used.

Conventional resistance welding practices may also be employed for joining ARMCO PH 13-8 Mo Stainless Steel.





# ARMCO® PH 13-8 Mo STAINLESS STEEL

## Fabrication

TABLE 24 – MECHANICAL PROPERTIES OF ARMCO PH 13-8 Mo STAINLESS STEEL WELDMENTS\* 38 mm (0.75 in.) THICK PLATE

Sample Condition	UTS, MPa (ksi)	0.2% YS, MPa (ksi)	Elong % in 35 mm (1.4")	Reduction of Area %	Failed In
Unwelded Base Plate H 950	1551 (225)	1435 (208)	16	62	–
Weld + H 950	1344 (195)	1103 (160)	13	47	WM
Weld + Condition A + H 950	1469 (213)	1344 (195)	18	20	WM
Unwelded Base Plate H 1100	1103 (160)	910 (132)	22	71	–
Weld + H 1100	1048 (152)	648 (94)	20	70	WM
Weld + Condition A + H 1100	1014 (147)	662 (96)	20	60	WM

\*Gas Tungsten Arc Welding (GTAW) process. Base plate welded in Condition A. WPH 13-8 Mo filler metal used. Average of duplicate tests from one heat.

## ARMCO® PH 13-8 Mo STAINLESS STEEL

### Corrosion Resistance

The general level of corrosion resistance of ARMCO PH 13-8 Mo Stainless Steel exceeds that of Types 410 and 431 but is not as good as that of ARMCO 17-4 PH Stainless Steel, based on laboratory immersion tests in both strongly oxidizing and reducing media. In all heat-treated conditions, PH 13-8 Mo Stainless Steel exhibits very little rusting after 500 hours exposure to 5% salt fog at 35 °C (95 °F).

The pitting resistance of ARMCO PH 13-8 Mo Stainless Steel is approximately equal to that of 17-4 PH and Type 304 stainless steels. When exposed to marine atmosphere, ARMCO PH 13-8 Mo Stainless Steel gradually develops a superficial overall layer of rust with shallow pits averaging about 0.07 – 0.10 mm (0.003 – 0.004 in.) deep.

Like other precipitation hardening stainless steels, the corrosion resistance of ARMCO PH 13-8 Mo Stainless Steel is greatest in the fully hardened condition and decreases very slightly as the aging temperature is increased.

#### HYDROGEN EMBRITTLEMENT

Hydrogen embrittlement is a potential threat to all high strength martensitic steels wherever the reduction of hydrogen ions to atomic hydrogen may occur. Commonplace examples are aqueous corrosion, cathodic protection to prevent corrosion, galvanic coupling with less noble metals and electroplating.

When exposed to 18% HCl – 1% SeO<sub>2</sub> (selenium dioxide) solution and stressed to 690 MPa (100 ksi) in direct tension, ARMCO PH 13-8 Mo Stainless Steel aged at temperatures ranging from 482 – 566 °C (900 – 1050 °F) failed from hydrogen embrittlement within two hours. Aging at temperatures above 593 °C (1100 °F) conferred immunity to cracking, while at 593 °C (1100 °F) – a borderline situation existed – with material sometimes resistant to cracking, and sometimes not.

These observations are analogous to those for ARMCO 17-4 PH with approximately equal resistance to cracking exhibited by both alloys in the various heat-treated conditions. Both alloys are superior to Type 410 in resistance to cracking from hydrogen embrittlement.

Despite the susceptibility of both ARMCO PH 13-8 Mo and ARMCO 17-4 PH Stainless Steels to hydrogen embrittlement that is shown by this severe test, we are not aware of more than a few isolated instances of their failure in service by this mechanism. Apparently, under nearly all conditions of use, these alloys possess adequate resistance to hydrogen embrittlement. Where this problem is acute and strength requirements permit, these alloys should be aged at temperatures of 593 °C (1100 °F) or higher to insure freedom from cracking.

#### HYDROGEN SULFIDE

ARMCO PH 13-8 Mo Stainless Steel can be used to advantage in sour oil and gas environments where other martensitic stainless steels are borderline or deficient. When heat treated at temperatures of 593 °C (1100 °F) and above, ARMCO PH 13-8 Mo Stainless Steel exhibits both substantially greater strength and better resistance to sulfide stress cracking than ARMCO 17-4 PH and Type 410 in their most resistant conditions.

The laboratory data Table 25 were obtained in a room temperature solution containing 5% NaCl and 0.5% acetic acid, saturated with H<sub>2</sub>S, following NACE TM0177.

#### MARINE STRESS CORROSION

ARMCO PH 13-8 Mo Stainless Steel is the most resistant of the hardenable stainless steels to stress-corrosion cracking. It offers higher useful mechanical properties than any other ferrous base material under extreme environmental conditions.

Table 26's data was obtained on 1.6 mm (0.062 in.) thick smooth bent-beam samples of ARMCO PH 13-8 Mo Stainless Steel exposed in triplicate at a location 24 m (80 ft) from the ocean.

ARMCO PH 13-8 Mo Stainless Steel should be precipitation hardened at 574 °C (1000 °F) or above if service conditions involve exposure to marine atmosphere under high levels of stress. Likewise, weldments should be resolution treated and aged at temperatures in this range if service conditions are conducive to stress-corrosion cracking.



# ARMCO® PH 13-8 Mo STAINLESS STEEL

## Corrosion Resistance

**TABLE 25 – STRESS-CRACKING RESISTANCE OF ARMCO PH 13-8 Mo, ARMCO 17-4 PH AND TYPE 410 STAINLESS STEELS IN NaCl-ACETIC ACID-H<sub>2</sub>S SOLUTION**

Alloy	Heat Treatment	0.2% Yield Strength, MPa (ksi)	Threshold Stress, *MPa (ksi)	Threshold Stress, * % of 0.2% YS
PH 13-8 Mo	H 1100	965 (140)	379 (55)	39
	H 1125	827 (120)	586 (85)	71
	H 1150	793 (115)	517 (75)	65
17-4 PH	H 1150 + 1150	793 (115)	138 (20)	17
	H 1150 M	586 (85)	172 (25)	29
Type 410	1200 °F (677 °C) 4 hrs. +	621 (90)	103 (15)	17
	1150 °F (621 °C) 4 hrs.			

\*Threshold stress is defined as the maximum stress at which no failure occurs after 720 hrs. exposure to standard NACE solution at room temperature. Data represent tests from one heat of ARMCO PH 13-8 Mo Stainless Steel and two heats of ARMCO 17-4 PH and Type 410.

**TABLE 26 – MARINE STRESS – CORROSION RESISTANCE**

Heat	0.2% Yield Strength, MPa (ksi)	Time to Failure, Days, Under Stress of	
		100% Yield Strength	75% Yield Strength
Condition A D	827 (120)	NF*, NF, NF	NF, NF, NF
Condition H 950	A	353, 1077**	1077, 1856, 6655
	B	86, 86, 165	1241, 2354, 4104
	C	107, 160, 165	44, 127, 165
	D	32, 70, 70	97, 120, 1399
Condition H 1000	A	1917, 6392, NF	NF, NF, NF
	B	1150, 2354, NF	2354, 3048, NF
	C	157, 4325, NF	1989, 3048, NF
	D	97, 160, NF	783, 1849, 4443
Condition H 1050 A	1186 (172)	NF, NF, NF	NF, NF, NF
Solution Annealed + Welded + H 1000	A	43, 43, 43	43, 100
Solution Annealed + Welded + Solution Treated + H 1000	A	NF, NF, NF	NF, NF, NF

\*NF indicates no failure to date. Tests were begun July 25, 1967 for Heat A, May 9, 1962 for Heats B and C, and June 3, 1971 for Heat D. Tests are continuing.

\*\*Only two specimens tested.

# MAKING INNOVATION HAPPEN



SAFETY | QUALITY | PRODUCTIVITY | INNOVATION



## **AK Steel International B.V.**

Rat Verlegstraat 2A  
4815 NZ Breda  
The Netherlands  
+31.(0)76.523.73.00

## **AK Steel International B.V.**

Germany Branch  
Holzmarkt 1  
50676 Cologne  
Germany  
+49.(0)221.97352.0

## **AK Steel Merchandising S.A.**

Muntaner, 374 – 376  
08006 Barcelona  
Spain  
+34.93.209.41.77

**[www.aksteel.eu](http://www.aksteel.eu)**

AK Steel International is a wholly owned subsidiary of AK Steel.

AK Steel is a leading producer of flat-rolled carbon, stainless and electrical steel products, primarily for the automotive, infrastructure and manufacturing, including electrical power, and distributors and converters markets. Through its subsidiaries, the company also provides customer solutions with carbon and stainless steel tubing products, die design and tooling, and hot- and cold-stamped components. Headquartered in West Chester, Ohio (Greater Cincinnati), the company has approximately 9,500 employees at manufacturing operations in the United States, Canada and Mexico, and facilities in Western Europe. Additional information about AK Steel is available at [www.aksteel.com](http://www.aksteel.com).

The information and data in this document are accurate to the best of our knowledge and belief, but are intended for general information only. Applications suggested for the materials are described only to help readers make their own evaluations and decisions, and are neither guarantees nor to be construed as express or implied warranties of suitability for these or other applications.

Data referring to material properties are the result of tests performed on specimens obtained from specific locations of the products in accordance with prescribed sampling procedures; any warranty thereof is limited to the values obtained at such locations and by such procedures. There is no warranty with respect to values of the materials at other locations.

AK, the AK Steel logo, ARMCO, the ARMCO logo, NITRONIC, 15-5 PH, 17-4 PH, 17-7 PH and 18 SR are registered trademarks of the AK Steel Corporation. ©2019 AK Steel. All Rights Reserved.